

Installation and User Manual version 1.00

WDESK-G WINOX-G/2G

3/6/14 Products



EN55022:2010 EN61000-6-2:2005 EN61000-6-4:2007

SYSTEM IDENTIFICATION

KEY TO SYMBOLS

Below are the symbols used in the manual to draw the reader's attention:



Warning! Risk of electrocution.



Warning! This operation must be performed by skilled workers.



Read the following indications carefully.



Further information.

GUARANTEE

24 months from the delivery document date. The guarantee covers only defected parts and includes the replacement parts and labour. All shipping and packing costs are paid by the customer. It is possible to have the repair in guarantee on condition that the returned product has not been transformed, damaged or repaired without authorization. No guarantee is applicable on returned products without the original label and/or serial number. No guarantee against misuse.

Batteries: LCC provides 1 year guarantee from the date of delivery note, against material defects or battery manufacturing faults.

Disposal of Waste Equipment by Users in Private Households in the European Union



This symbol on the product or on its packaging indicates that this product must not be disposed of with your other household waste. It is your responsibility to dispose of your waste equipment by handing it over to a designated collection point for the recycling of waste electrical and electronic equipment. The separate collection and recycling of your waste equipment at the time of disposal will help preserve natural resources and protect human health and the environment. For more information about where you can drop off your waste equipment for recycling, please contact your local waste disposal Authority or the equipment retailer.

TABLE OF CONTENTS

USER WARNINGS	1
RECOMMENDATIONS FOR CORRECT INSTALLATION OF WEIGHING INSTRUMENTS .	1
RECOMMENDATIONS FOR CORRECT INSTALLATION OF THE LOAD CELLS	1
LOAD CELL INPUT TEST (QUICK ACCESS)	3
LOAD CELL TESTING	3
MAIN SPECIFICATIONS OF THE INSTRUMENT	4
BUFFER BATTERY	6
AFTER A BLACKOUT	6
TECHNICAL SPECIFICATIONS	7
ELECTRICAL CONNECTIONS	8
BASIC INFORMATION	8
WIRING DIAGRAM: 3 PRODUCTS	8
WIRING DIAGRAM: 6 PRODUCTS	9
WIRING DIAGRAM: 14 PRODUCTS	10
<i>CHANGING VOLTAGE 115VAC / 230VAC (WDESK)</i>	11
<i>KEY TO P, Q, X TYPE CONNECTORS</i>	11
<i>KEY TO D TYPE CONNECTORS</i>	12
<i>KEY TO "RELE6PROD" MODULE TERMINALS</i>	14
<i>KEY TO "RELE14PROD" MODULE TERMINALS</i>	15
INTRODUCTION TO THE OPERATION	16
KEYS AND SYMBOLS FUNCTIONS	17
MENU MAP	18
SYSTEM PARAMETERS	18
BATCHING CONSTANTS	19
LCD GRAPHIC DISPLAY	20
BASIC INFORMATION	20
LCD GRAPHIC DISPLAY CONFIGURATION	21
<i>LANGUAGE SETTING</i>	21
<i>CUSTOMIZING MESSAGES OF LCD GRAPHIC DISPLAY</i>	22
INSTRUMENT COMMISSIONING	23
PROGRAMMING OF SYSTEM PARAMETERS	24
THEORETICAL CALIBRATION	24
<i>TARE WEIGHT ZERO SETTING</i>	25
<i>ZERO VALUE MANUAL ENTRY</i>	25
REAL CALIBRATION (WITH SAMPLE WEIGHTS)	25
FILTER ON THE WEIGHT	26
<i>ANTI PEAK</i>	27
ZERO PARAMETERS	27
<i>RESETTABLE WEIGHT SETTING FOR SMALL WEIGHT CHANGES</i>	27
<i>AUTOMATIC ZERO SETTING AT POWER-ON</i>	27
<i>ZERO TRACKING</i>	28

SETTING UNITS OF MEASURE.....	28
OUTPUTS AND INPUTS CONFIGURATION	28
SEMI-AUTOMATIC TARE (NET/GROSS)	29
PRESET TARE (SUBTRACTIVE TARE DEVICE).....	30
SEMI-AUTOMATIC ZERO (WEIGHT ZERO-SETTING FOR SMALL VARIATIONS)	30
ANALOG OUTPUT(ONLY FOR INSTRUMENTS WHERE THIS OPTION IS AVAILABLE) ..	31
SERIAL COMMUNICATION SETTING.....	33
<i>RS232 SERIAL COMMUNICATION</i>	34
<i>RS485 SERIAL COMMUNICATION</i>	34
<i>DIRECT CONNECTION BETWEEN RS485 AND RS232 WITHOUT CONVERTER</i>	34
ALARM RELAY CLOSURE	35
TEST	35
ENERGY SAVING	36
DATE AND TIME SETTING	36
OPERATION SETTINGS.....	36
INFO MENU	37
PROGRAMMING OF BATCHING CONSTANTS.....	38
MINIMUM WEIGHT.....	38
MAXIMUM WEIGHT	38
SAFE EMPTYING TIME	38
WAITING TIME.....	38
NO PRODUCT LOAD TIME	38
NO PRODUCT UNLOAD TIME	39
FALL.....	39
TOLERANCE.....	39
SLOW	40
TAPPING FUNCTION.....	40
AUTOTARE	40
AUTOTARE DELAY	40
PRINT AT CYCLE END.....	41
CHECKING PC PRESENCE	41
WAITING CONFIRMATION FROM PC (SLAVE)	41
SWITCHING OF THE ALARM/SLOW RELAY ON WEIGHT	41
FORMULAS PROGRAMMING.....	42
DELETING FORMULAS.....	42
BATCHING	43
BATCHING START FROM EXTERNAL CONTACT	44
BATCHING START FOR SINGLE PRODUCT WITH AUTOMATIC STOP.....	45
BATCHING START FOR SINGLE PRODUCT WITH STOP BY KEYBOARD	45
UNLOADING START WITH AUTOMATIC STOP.....	45
DISPLAYING DURING BATCHING	46
<i>PRODUCT DETAIL DISPLAY</i>	46
BATCHING STOP	47

RESUME BATCHING AFTER A POWER CUT	47
TOTALS MANAGEMENT.....	48
CONSUMPTION	48
PRODUCTION	49
STOCKS	49
ALARMS.....	51
PRINTING EXAMPLES	53
RESERVED FOR THE INSTALLER	56
MENU LOCKING	56
MENU UNLOCKING.....	56
TEMPORARY MENU UNLOCKING.....	56
DATA DELETION AND PROGRAM SELECTION.....	56
KEYPAD OR DISPLAY LOCKING	57

USER WARNINGS

RECOMMENDATIONS FOR THE PROPER USE OF WEIGHING INSTRUMENT

- Keep away from heat sources and direct sunlight
- Repair the instrument from rain (except special IP versions)
- Do not wash with water jets (except special IP versions)
- Do not dip in water
- Do not spill liquid on the instrument
- Do not use solvents to clean the instrument
- Do not install in areas subject to explosion hazard (except special Atex versions)

RECOMMENDATIONS FOR CORRECT INSTALLATION OF WEIGHING INSTRUMENTS

The terminals indicated on the instrument's wiring diagram to be connected to earth must have the same potential as the weighed structure (same earthing pit or earthing system). If you are unable to ensure this condition, connect with an earthing wire the terminals of the instrument (including the terminal – SUPPLY) to the weighed structure.

The cell cable must be individually led to its panel input and not share a conduit with other cables; connect it directly to the instrument terminal strip without breaking its route with support terminal strips.

Use "RC" filters on the instrument-driven solenoid valve and remote control switch coils.

Avoid inverters in the instrument panel; if inevitable, use special filters for the inverters and separate them with sheet metal partitions.

The panel installer must provide electric protections for the instruments (fuses, door lock switch etc.).

It is advisable to leave the equipment always switched on to prevent the formation of condensation.

MAXIMUM CABLE LENGTHS

- RS485: 1000 metres with AWG24, shielded and twisted cables
- RS232: 15 metres for baud rates up to 19200
- Analog current output: up to 500 metres with 0.5 mm² cable
- Analog voltage output: up to 300 metres with 0.5 mm² cable

RECOMMENDATIONS FOR CORRECT INSTALLATION OF THE LOAD CELLS

INSTALLING LOAD CELLS: The load cells must be placed on rigid, stable in-line structures; it is important to use the mounting modules for load cells to compensate for misalignment of the support surfaces.

PROTECTION OF THE CELL CABLE: Use water-proof sheaths and joints in order to protect the cables of the cells.

MECHANICAL RESTRAINTS (pipes, etc.): When pipes are present, we recommend the use of hoses and flexible couplings with open mouthpieces with rubber protection; in case of hard pipes, place the pipe support or anchor bracket as far as possible from the weighed structure (at a distance at least 40 times the diameter of the pipe).

CONNECTING SEVERAL CELLS IN PARALLEL: Connect several cells in parallel by using - if necessary - a watertight junction box with terminal box. The cell connection extension cables must be shielded, led individually into their piping or conduit and laid as far as possible from the power cables (in case of 4-wire connections, use cables with 4x1 mm² minimum cross-section).

WELDING: Avoid welding with the load cells already installed. If this cannot be avoided, place the welder ground clamp close to the required welding point to prevent sending current through the load cell body.

WINDY CONDITIONS - KNOCKS - VIBRATIONS: The use of weigh modules is strongly recommended for all load cells to compensate for misalignment of the support surfaces. The system designer must ensure that the plant is protected against lateral shifting and tipping relating to: shocks and vibration; windy conditions; seismic conditions in the installation setting; stability of the support structure.

EARTHING THE WEIGHED STRUCTURE: By means of a copper wire with suitable cross-section, connect the cell upper support plate with the lower support plate, then connect all the lower plates to a single earthing system. Electrostatic charges accumulated because of the product rubbing against the pipes and the weighed container walls are discharged to the ground without going through or damaging the load cells. Failure to implement a proper earthing system might not affect the operation of the weighing system; this, however, does not rule out the possibility that the cells and connected instrument may become damaged in the future. It is forbidden to ensure earthing system continuity by using metal parts contained in the weighed structure.

**FAILURE TO FOLLOW THE INSTALLATION RECOMMENDATIONS WILL BE CONSIDERED
A MISUSE OF THE EQUIPMENT**

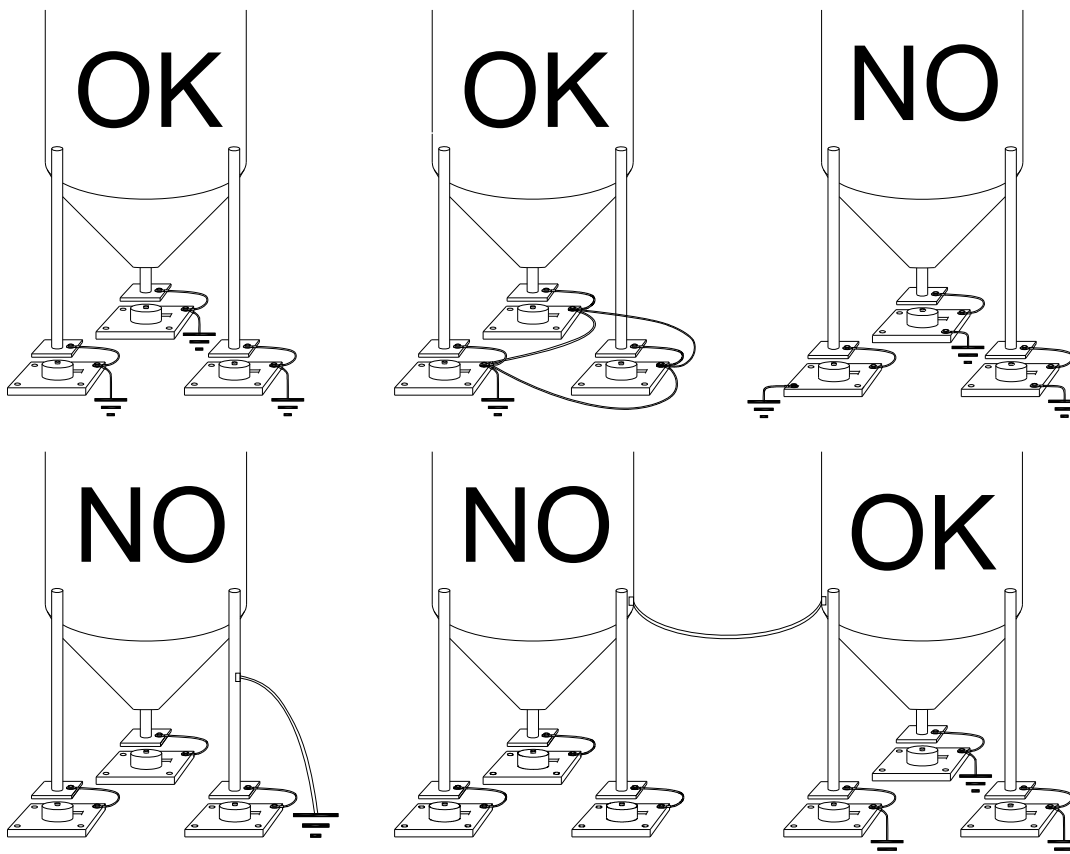

LOAD CELL INPUT TEST (QUICK ACCESS)



From the weight display, press ▲ for 3 seconds; the response signal of the load cells is displayed, expressed in mV with four decimals.

LOAD CELL TESTING

Load cell resistance measurement (use a digital multimeter):

- Disconnect the load cells from the instrument and check that there is no moisture in the cell junction box caused by condensation or water infiltration. If so, drain the system or replace it if necessary.
- The value between the positive signal wire and the negative signal wire must be equal or similar to the one indicated in the load cell data sheet (output resistance).
- The value between the positive excitation wire and the negative excitation wire must be equal or similar to the one indicated in the load cell data sheet (input resistance).
- The insulation value between the shield and any other cell wire and between any other cell wire and the body of the load cell must be higher than 20 Mohm.

Load cell voltage measurement (use a digital multimeter):

- Take out the load cell to be tested from underneath the container, or alternatively, lift the container support.
- Make sure that the excitation of two wires of the load cell connected to the instrument (or amplifier) is 5 Vdc \pm 3%.
- Measure the response signal between the positive and the negative signal wires by directly connecting them to the tester, and make sure that it is comprised between 0 and 0.5 mV.
- Apply load to the cell and make sure that there is a signal increment.

IF ONE OF THE ABOVE CONDITIONS IS NOT MET, PLEASE CONTACT THE TECHNICAL ASSISTANCE SERVICE.

MAIN SPECIFICATIONS OF THE INSTRUMENT

Indicator with 6-wire load cell input installable on table, panel front, wall or column; 6-key membrane keypad with buzzer, real-time clock/calendar with buffer battery.





Two serial ports (RS485 and RS232) for connection to: PC/PLC up to 32 instruments (max 99 with line repeaters) by ASCII or ModBus R.T.U. protocol, remote display, printer. Optional: integrated Profibus DP, DeviceNet, CANopen, Profinet IO, Ethernet/IP, Ethernet TCP/IP, Modbus/TCP output.

Instruments with P, D type connectors: included switching power supply plug 24 V 450 mA, input 100÷240 VAC, 3 meters long cable.







Display:

Model	Display	Resolution	Viewing area
WDESK-G WINOX-G	STN transmissive graphic LCD, white on blue, backlit	240x64 pixel	133x39 mm
WINOX-2G	STN transmissive graphic LCD, white on blue, backlit	240x128 pixel	128x75 mm

Dimensions:

WDESK	Version	Max. encumbrance	Drilling
	P - PG9 cable gland IP67 protection rating Power supply included	122x226x164 mm (connectors included)	96x186 mm
	Q - Removable terminal strip (panel front) Front panel IP67 protection rating	122x226x152 mm (connectors included)	92x186 mm
	D - D-Sub tray IP40 protection rating Power supply included	122x226x189 mm (connectors included)	96x186 mm
	X - Atex cable gland IP67 Atex  II3GD version (areas 2 -22) IP67 protection rating	122x226x164 mm (connectors included)	96x186 mm

	Wall installation with bracket (can also be installed on table)	122x230x250 mm ca. (bracket included)	
--	--	--	--

WINOX	Type of connectors	Max. encumbrance	Drilling
	P - PG9 cable gland IP68 protection rating Power supply included	206x286x108 mm (connectors included)	160x248 mm
	Q - Removable terminal strip (panel front) Front panel IP68 protection rating	206x286x96 mm (connectors included)	160x248 mm
	D - D-Sub tray (table) IP40 protection rating Power supply included	206x286x85 mm (connectors included)	
	X - Atex cable gland IP68 Atex  II3GD version (areas 2 -22) IP68 protection rating	206x286x108 mm (connectors included)	160x248 mm
	Wall installation with bracket (can also be installed on table)	206x286x187 mm ca. (bracket included)	

BUFFER BATTERY

The instrument is equipped with an internal battery that allows to keep active the internal clock even in the event of power failure.



At the first start and after long periods of inactivity, leave the instrument on for at least 12 hours to fully charge the battery.

AFTER A BLACKOUT

After a blackout the instrument DOES NOT come on again automatically, you have to press **ON**. To guarantee an automatic restart after a blackout, disable the ON key as follows:

- disconnect power supply and open the instrument;
- identify flat connectors coming from the keypad on the main board;
- extract the 4-pole connector;
- short-circuit the following pins using the unused jumper inside the instrument:
 - WDESK: the two pins further in compared to the main board (see picture to the left);
 - WINOX: the two outer pins compared to the main board (see picture to the right);
- connect the 4-pole flat to the two pins still free complying with initial orientation.

WDESK

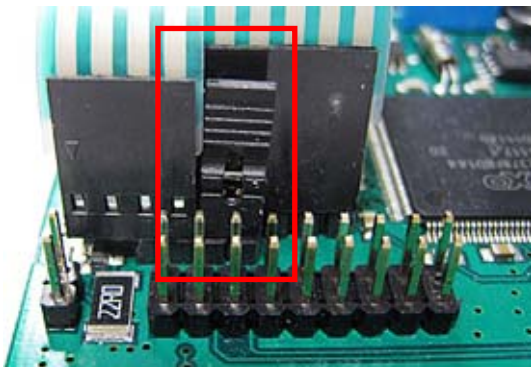

WINOX

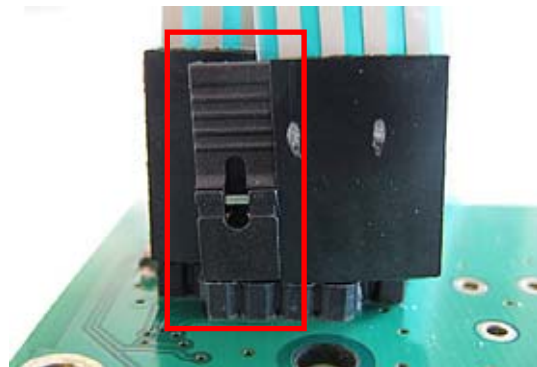

TECHNICAL SPECIFICATIONS

POWER SUPPLY and CONSUMPTION (VDC)	12/24 VDC $\pm 10\%$; 6 W (standard)
POWER SUPPLY and CONSUMPTION (VAC)	115/230 VAC; 50-60 Hz; 6 VA (optional only for WDESK – WINOX-P)
NO. OF LOAD CELLS IN PARALLEL and SUPPLY LINEARITY / ANALOG OUTPUT LINEARITY	max 8 (350 ohm); 5 VDC / 120 mA < 0.01% F.S.; < 0.01% F.S.
THERMAL DRIFT / ANALOG OUTPUT THERMAL DRIFT	< 0.0005% F.S./ $^{\circ}\text{C}$; < 0.003% F.S./ $^{\circ}\text{C}$
A/D CONVERTER	24 bit (16000000 points)
MAX DIVISIONS (with measurement range: ± 10 mV = sens. 2 mV/V)	± 999999
MEASUREMENT RANGE	± 39 mV
MAX SENSITIVITY OF USABLE LOAD CELLS	± 7 mV/V
MAX CONVERSIONS PER SECOND	300 conversions/second
DISPLAY RANGE	± 999999
NO. OF DECIMALS / DISPLAY INCREMENTS	0÷4 / x 1 x 2 x 5 x 10 x 20 x 50 x 100
DIGITAL FILTER / READINGS PER SECOND	0.012÷7 s / 5÷300 Hz
RELAY LOGIC OUTPUTS	N. 5 - max 115 VAC; 150 mA (N. 4 – analog output version)
LOGIC INPUTS	N. 3 - optoisolated 5 - 24 VDC PNP (N. 2 – analog output version)
SERIAL PORTS	RS485, RS232
BAUD RATE	2400, 4800, 9600, 19200, 38400, 115200
HUMIDITY (non condensing)	85%
STORAGE TEMPERATURE	-30 $^{\circ}\text{C}$ +80 $^{\circ}\text{C}$
WORKING TEMPERATURE	-20 $^{\circ}\text{C}$ +60 $^{\circ}\text{C}$
OPTOISOLATED ANALOG OUTPUT (OPTIONAL) 16 bit - 65535 divisions	0÷20 mA; 4÷20 mA (max 300 ohm); 0÷10 V; 0÷5 V; ± 10 V; ± 5 V (min 10 kohm)

	RELAY LOGIC OUTPUTS	N. 5 - max 30 VAC, 60 VDC; 150 mA (N. 4 – analog output version)
	WORKING TEMPERATURE	-20 $^{\circ}\text{C}$ +50 $^{\circ}\text{C}$
	Equipment to be powered by 12-24 Vdc LPS or Class 2 power source.	

RELE6PROD TECHNICAL SPECIFICATIONS	
POWER SUPPLY and CONSUMPTION (VDC)	12/24 VDC (standard) $\pm 10\%$; 2 W
POWER SUPPLY and CONSUMPTION (VAC)	115/230 VAC (optional); 50-60 Hz; 1.5 VA
RELAY LOGIC OUTPUTS	N. 8 - max 115 VAC; 2 A
HUMIDITY (non condensing)	85%
STORAGE TEMPERATURE	-30 $^{\circ}\text{C}$ +80 $^{\circ}\text{C}$
WORKING TEMPERATURE	-20 $^{\circ}\text{C}$ +60 $^{\circ}\text{C}$

ELECTRICAL CONNECTIONS

BASIC INFORMATION

- It is recommended that the power supply negative pole be grounded (WDESK-D, WINOX: connect the earthing system to the dedicated external terminal \perp).
- It is possible to supply up to eight 350 ohm load cells or sixteen 700 ohm load cells.
- For 4-wire load cells, make a jumper between EX- and REF- and between EX+ and REF+.
- Connect terminal “- SUPPLY” to the RS485 common of the connected instruments in the event that these receive alternating current input or that they have an optoisolated RS485.
- In case of an RS485 network with several devices it is recommended to activate the 120 ohm termination resistance on the two devices located at the ends of the network, as described in section **RS485 SERIAL CONNECTION**.
- Option **E/EC**: selects the first 12 formulas.

WIRING DIAGRAM: 3 PRODUCTS

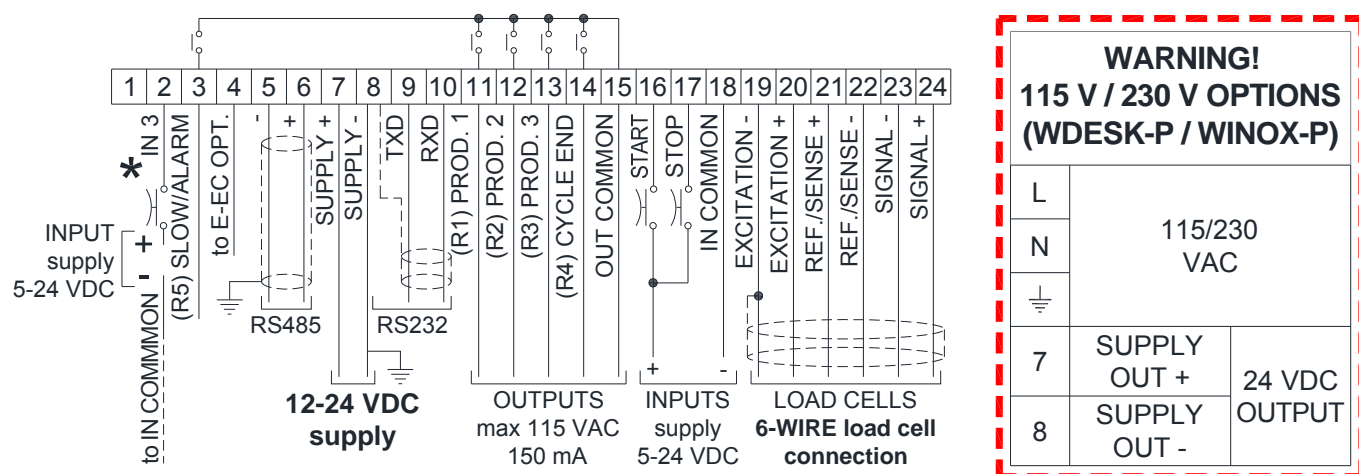

(1) ANALOG OUTPUT OPTION

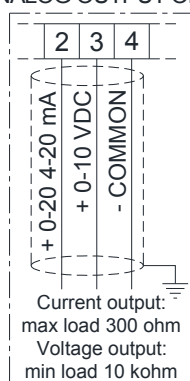

4-WIRE load cell connection

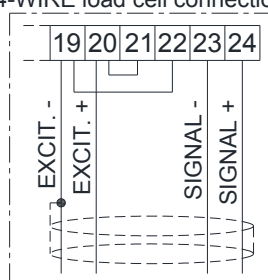

E OPTION

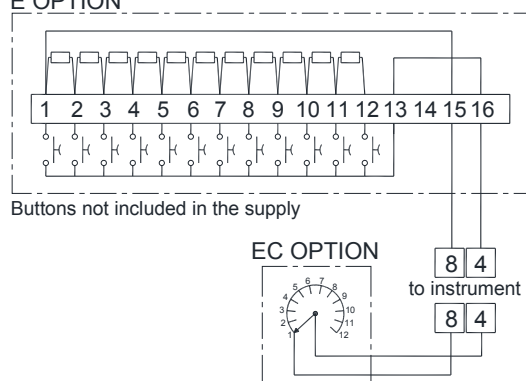

★) The **IN3** input can have the following functions:

- **APPROVAL** (default)
- **SEMI-AUTOMATIC ZERO**
- **NET/GROSS WEIGHT**

(1) If the analog output is present (ANALOG OUTPUT OPTION) the following are no longer available:

- **IN3** input
- **SLOW/ALARM** output
- **E/EC** options

WARNING: connect power supply specified on the plate found on the back of the instrument. In 115 V and 230 V versions, terminals “+ SUPPLY” and “- SUPPLY” generate continuous voltage at 24 Vdc only to be used as power supply for instrument inputs.

WIRING DIAGRAM: 6 PRODUCTS

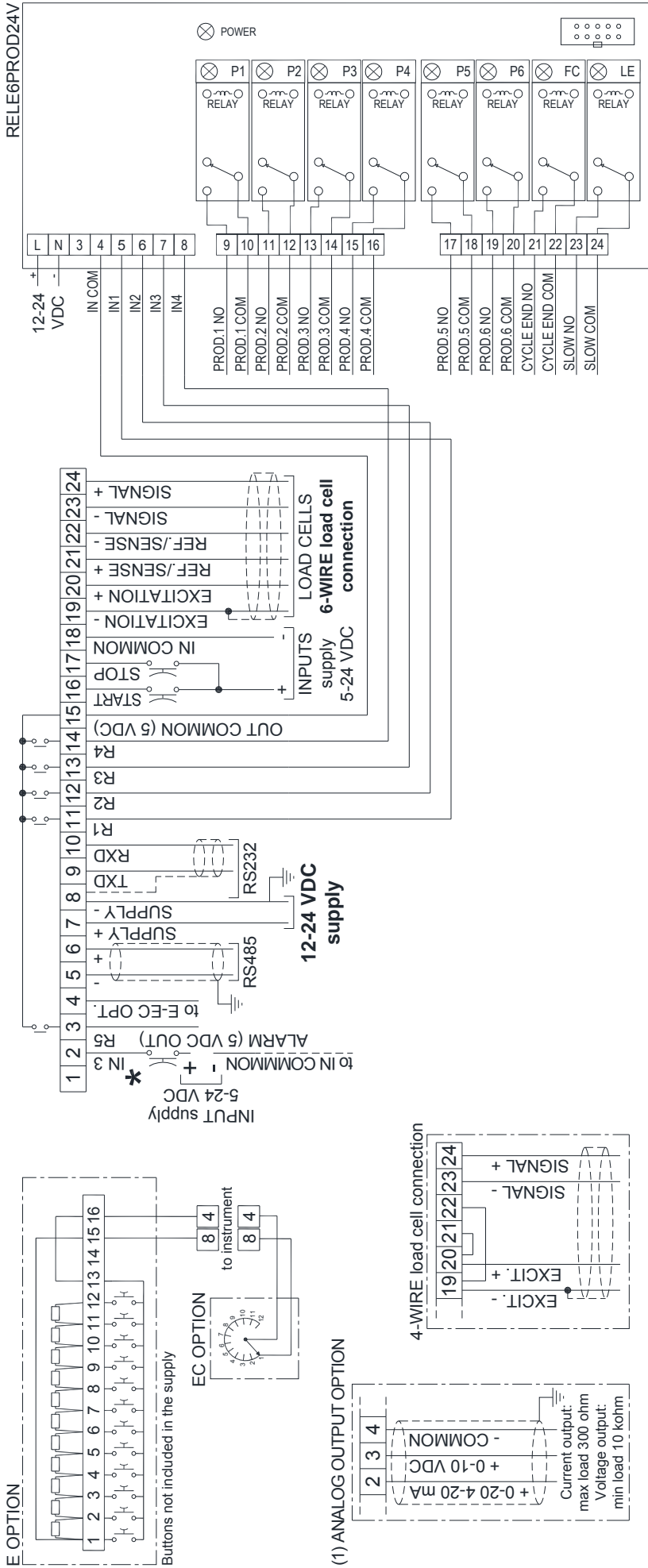

RELE6PROD MODULE						
R1	R2	R3	R4	OUTPUTS		
I	I	I	0	PROD. 1		
0	I	I	0	PROD. 2		
I	0	I	0	PROD. 3		
0	0	I	0	PROD. 4		
I	I	0	0	PROD. 5		
0	I	0	0	PROD. 6		
I	0	0	0	CYCLE END		
X	X	X	I	SLOW		

**WARNING! 115 V / 230 V OPTIONS
(WDESK-P / WINOX-P)**

RELE6PROD -115V/-230V

WEIGHT INDICATOR	
L	115/230 VAC
N	
7	SUPPLY OUT + 24 VDC OUTPUT
8	SUPPLY OUT -

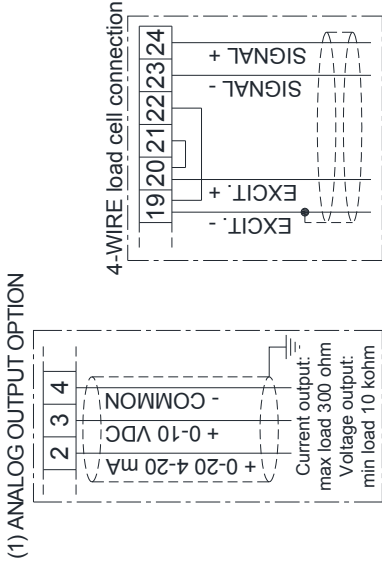
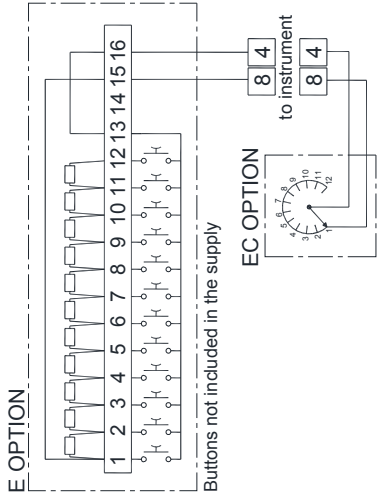

- ★) The IN3 input can have the following functions:
 - APPROVAL (default)
 - SEMI-AUTOMATIC ZERO
 - NET/GROSS WEIGHT
 - (1) If the analog output is present (ANALOG OUTPUT OPTION) the following are no longer available:
 - IN3 input
 - ALARM output
 - E/EC options
- WARNING:** connect power supply specified on the plate found on the back of the instrument. In 115 V and 230 V versions, terminals "+ SUPPLY" and "- SUPPLY" generate continuous voltage at 24 Vdc only to be used as power supply for instrument inputs.

WIRING DIAGRAM: 14 PRODUCTS

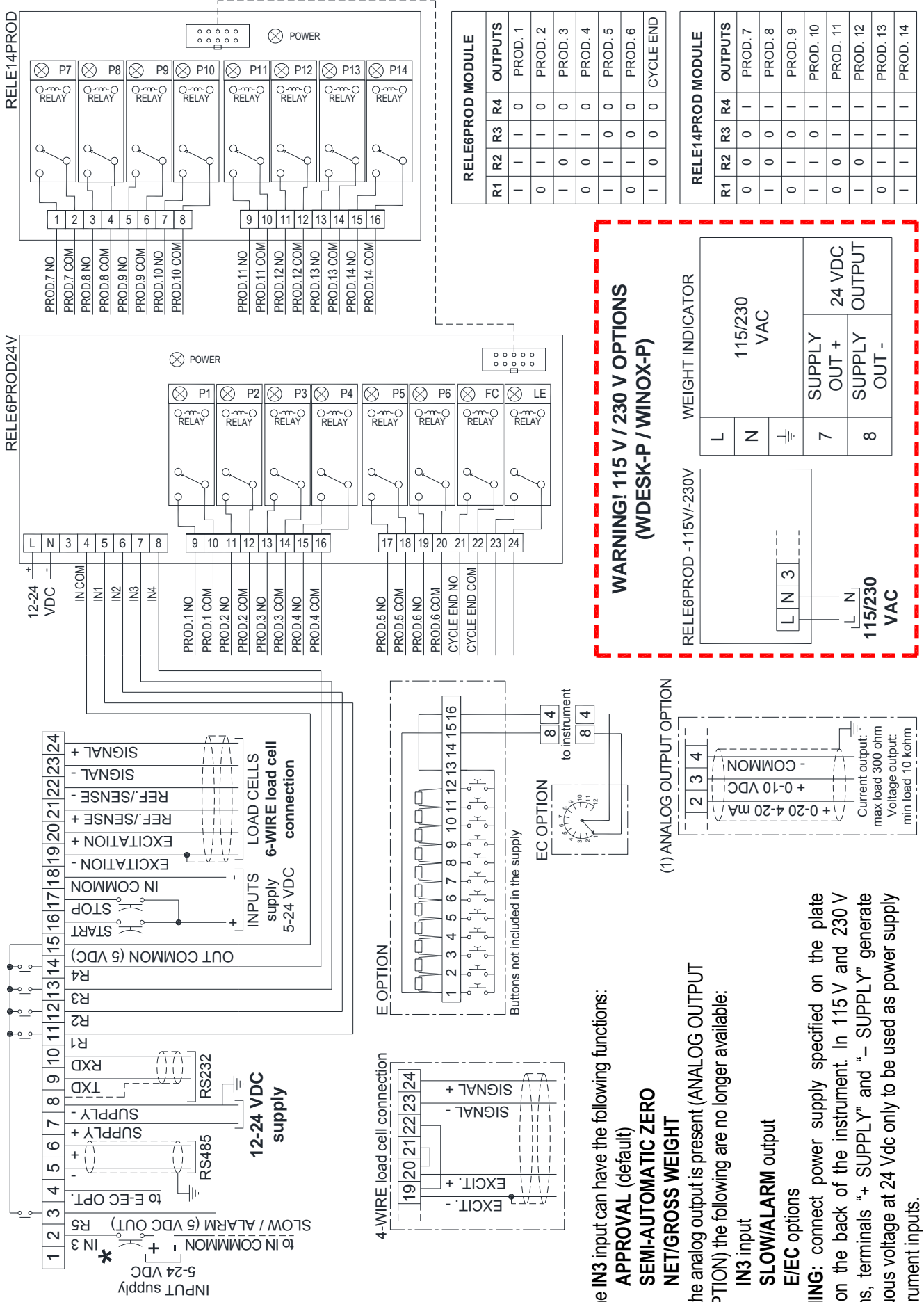

★) The IN3 input can have the following functions:

- APPROVAL (default)
- SEMI-AUTOMATIC ZERO
- NET/GROSS WEIGHT

(1) If the analog output is present (ANALOG OUTPUT OPTION) the following are no longer available:

- IN3 input
- SLOW/ALARM output
- E/EC options

WARNING: connect power supply specified on the plate found on the back of the instrument. In 115 V and 230 V versions, terminals "+ SUPPLY" and "- SUPPLY" generate continuous voltage at 24 Vdc only to be used as power supply for instrument inputs.

CHANGING VOLTAGE 115VAC / 230VAC (WDESK)

Access instrument board by removing the six bottom screws and work on the welding side: join the red points using a stiff wire.

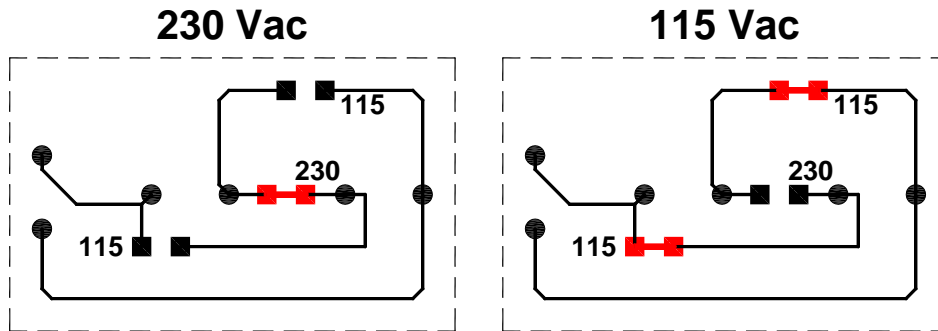

KEY TO P, Q, X TYPE CONNECTORS

Terminal	Signal	Terminal	Signal
1		14	OUTPUT No. 4: - CYCLE END (3 PROD. version) - connect to RELE6PROD module (6/14 PROD. versions)
2	INPUT No. 3: selectable (+VDC min 5 V max 24 V) <i>otherwise:</i> +ANALOG OUTPUT (0÷20 o 4÷20 mA)	15	OUTPUT COMMON
3	OUTPUT No. 5: - SLOW/ALARM (3/14 PROD. versions) - ALARM (6 PROD. version) <i>otherwise:</i> +ANALOG OUTPUT (0÷10 V)	16	INPUT No. 1: START (+VDC min 5 V max 24 V)
4	E/EC OPTION <i>otherwise:</i> -ANALOG OUTPUT COMMON	17	INPUT No. 2: STOP (+VDC min 5 V max 24 V)
5	RS485: -	18	INPUT COMMON (-VDC 0 V)
6	RS485: +	19	-LOAD CELL EXCITATION (-Exc) LOAD CELL SHIELD
7	+SUPPLY (12/24 VDC) 115/230 VAC optional version: +OUTPUT (24 VDC)*	20	+LOAD CELL EXCITATION (+Exc)

8	-SUPPLY (12/24 VDC) RS232, RS485: SHIELD, GND E/EC OPTION: GND 115/230 VAC optional version: -OUTPUT (24 VDC)* RS232, RS485: SHIELD, GND E/EC OPTION: GND	21	+LOAD CELL REF/SENSE
9	RS232: TXD	22	-LOAD CELL REF/SENSE
10	RS232: RXD	23	-LOAD CELL SIGNAL (-Sig)
11	OUTPUT No. 1: - PRODUCT 1 (3 PROD. version) - connect to RELE6PROD module (6/14 PROD. versions)	24	+LOAD CELL SIGNAL (+Sig)
12	OUTPUT No. 2: - PRODUCT 2 (3 PROD. version) - connect to RELE6PROD module (6/14 PROD. versions)	L	PHASE (115/230 VAC optional ver.)
13	OUTPUT No. 3: - PRODUCT 3 (3 PROD. version) - connect to RELE6PROD module (6/14 PROD. versions)	N	NEUTRAL (115/230 VAC optional ver.)
		\perp	GROUND (115/230 VAC optional ver.)

*) Use only as power supply for instrument inputs.



To access the terminal strip on the WDESK instruments with cable glands, you need to remove the bottom of the instrument unscrewing the six screws.

KEY TO D TYPE CONNECTORS

Connector	Pin	Signal	Internal terminal	Internal colour
P1 Power supply		+SUPPLY (12/24 VDC)	7	red
		-SUPPLY (12/24 VDC)	8	black
D1 Female Load cell	1	-LOAD CELL EXCITATION (-Exc)	19	black
	2	-LOAD CELL REF/SENSE	22	yellow
	3			
	4			
	5	LOAD CELL SHIELD	19	
	6	+LOAD CELL EXCITATION (+Exc)	20	red
	7	+LOAD CELL REF/SENSE	21	blue
	8	-LOAD CELL SIGNAL (-Sig)	23	white
	9	+LOAD CELL SIGNAL (+Sig)	24	green

D3 Male IN/OUT Analog output E/EC option	1	OUTPUT No.1 (max 24 V): - PRODUCT 1 (3 PROD. version) - connect to RELE6PROD module (6/14 PROD. versions)	11	yellow
	2	OUTPUT No.2 (max 24 V): - PRODUCT 2 (3 PROD. version) - connect to RELE6PROD module (6/14 PROD. versions)	12	blue
	3	OUTPUT No.3 (max 24 V): - PRODUCT 3 (3 PROD. version) - connect to RELE6PROD module (6/14 PROD. versions)	13	white
	4	OUTPUT No.4 (max 24 V): - CYCLE END (3 PROD. version) - connect to RELE6PROD module (6/14 PROD. versions)	14	green
	5	OUTPUT No.5 (max 24 V): - SLOW/ALARM (3/14 PROD. version) - ALARM (6 PROD. version) <i>otherwise:</i> +ANALOG OUTPUT (0-10 V)	3	orange
	6	OUTPUT COMMON (max 24 V)	15	purple
	7	INPUT No.1: START (+VDC min 5 V max 24 V)	16	grey
	8	INPUT No.2: STOP (+VDC min 5 V max 24 V)	17	pink
	9	INPUT No. 3: selectable (+VDC min 5 V max 24 V) <i>otherwise:</i> +ANALOG OUTPUT (0÷20 o 4÷20 mA)	2	brown
	10	INPUT COMMON (-VDC 0 V)	18	white/blue
	11	E/EC OPTION <i>otherwise:</i> -ANALOG OUTPUT COMMON	4	red
	12	E/EC OPTION: GND ANALOG OUTPUT: SHIELD	8	black
	13			
	14			
	15			
D4 Male RS232 serial port	1			
	2	RS232: RXD	10	yellow
	3	RS232: TXD	9	blue
	4			
	5	RS232: SHIELD, GND	8	black
	6			
	7			
	8			
	9			

D5 Male RS485 serial port with 24 VDC output	1	+OUTPUT (24 VDC)*	7	red
	2	-OUTPUT (24 VDC)*	8	black
	3			
	4	RS485: +	6	yellow
	5	RS485: SHIELD, GND	8	black
	6	RS485: -	5	blue
	7	RS485: -	5	blue
	8			
	9	RS485: +	6	yellow

*) Not available if the instrument is battery powered.
 Use only if the instrument is connected to the provided 24 VDC power supply.
 Maximum load: 5 W.

KEY TO "RELE6PROD" MODULE TERMINALS

Terminal	Signal	D3 pin	C9 pin
1	+SUPPLY (12/24 VDC)		
2	-SUPPLY (12/24 VDC)		
3			
4	INSTRUMENT OUTPUT COMMON	6	5
5	INSTRUMENT OUTPUT No. 1	1	1
6	INSTRUMENT OUTPUT No. 2	2	2
7	INSTRUMENT OUTPUT No. 3	3	3
8	INSTRUMENT OUTPUT No. 4	4	4
9	PRODUCT 1 NO		
10	PRODUCT 1 COM		
11	PRODUCT 2 NO		
12	PRODUCT 2 COM		
13	PRODUCT 3 NO		
14	PRODUCT 3 COM		
15	PRODUCT 4 NO		
16	PRODUCT 4 COM		
17	PRODUCT 5 NO		
18	PRODUCT 5 COM		
19	PRODUCT 6 NO		
20	PRODUCT 6 COM		
21	CYCLE END NO		
22	CYCLE END COM		
23	SLOW NO (6 PRODUCT version)		
24	SLOW COM (6 PRODUCT version)		

KEY TO "RELE14PROD" MODULE TERMINALS

Terminal	Signal
1	PRODUCT 7 NO
2	PRODUCT 7 COM
3	PRODUCT 8 NO
4	PRODUCT 8 COM
5	PRODUCT 9 NO
6	PRODUCT 9 COM
7	PRODUCT 10 NO
8	PRODUCT 10 COM
9	PRODUCT 11 NO
10	PRODUCT 11 COM
11	PRODUCT 12 NO
12	PRODUCT 12 COM
13	PRODUCT 13 NO
14	PRODUCT 13 COM
15	PRODUCT 14 NO
16	PRODUCT 14 COM

INTRODUCTION TO THE OPERATION

The batching programs for 3/6/14 products are used to realize a mixture of different products, which are loaded on a single weighing structure.

The instrument is able to load automatically a settable amount for each product, driving the relative batching organ (even two-speed) through the dedicated contact.

The instrument has the following features:

- Maximum 99 settable formulas (see section **FORMULAS PROGRAMMING**);
- Formulas programming in fixed or variable steps (see section **FORMULAS PROGRAMMING**);
- Batching resume after blackout (see section **RESUME BATCHING AFTER A POWER CUT**);
- Automatic fall calculation (see section **FALL**);
- Autotare at batching start (see section **AUTOTARE**);
- Tolerance error control (see section **TOLERANCE**);
- Precision batching through slow function (see section **SLOW**);
- Precision batching through tapping function (see section **TAPPING FUNCTION**);
- Consumption storage (see section **CONSUMPTION**);
- Production storage (see section **PRODUCTION**);
- Product stocks management (see section **STOCKS**);
- Print of batching data (see section **PRINT AT CYCLE END**);
- Alarm contact (see section **ALARM RELAY CLOSURE**);

BATCHING START:

- via keypad, setting formula and cycle number to be performed;
- via external contact (see section **BATCHING START FROM EXTERNAL CONTACT**).

For further information on the batching sequence, see section **BATCHING**.

FORMULAS PROGRAMMING IN STEPS:

The programming products order in formulas is, by default, fixed and ascending (**FIXED STEPS**); however it is still possible to program the products order, even repeating several times the same product (**VARIABLE STEPS**).

CONSUMPTION:

The instrument, at the end of every batching, stores the consumed amount for each product (see section **CONSUMPTION**).

PRODUCTION:

The instrument, at the end of every batching, stores the batched amount for each formula (see section **PRODUCTION**).

STOCKS:

The instrument manages product stocks and if their value fall below the minimum set, it displays an alarm (see section **STOCKS**).

INSTRUMENT CALIBRATION:















The instrument calibration can be performed both with **THEORETICAL CALIBRATION**, setting the instrument full scale and the load cells sensitivity (see section **THEORETICAL CALIBRATION**), and with **REAL CALIBRATION** through **SAMPLE WEIGHT** (see section **REAL CALIBRATION (WITH SAMPLE WEIGHTS)**).

ALARM MANAGEMENT:





If an alarm occurs during the batching, the instrument shows the alarm on the display, closes the related contact (if enable) and waits for operator intervention to abort or continue the batching.

KEYS AND SYMBOLS FUNCTIONS

KEYS

KEY	Short press	Long press (3 s)	Into menus
	Power-on	Power-off	
	Semi-automatic zero	Tare resetting	Cancel or return to previous menu
	Gross → Net	Net → Gross	Select figure to be modified
	Batching start		Select figure to be modified
	Batching stop		Modify figure or go to next menu item
	Print menu	mV load cell test	Modify figure or go to previous menu item
	Setting formulas and batching constants	Formula selection for START input (EC not present)	Confirm or enter in submenu
	Context-sensitive function keys: see corresponding symbol on LCD display		Context-sensitive function keys: see corresponding symbol on LCD display
	Setting general parameters (press  immediately followed by )		
	Setting preset tare (press  immediately followed by )		

SYMBOLS

SYMBOL	Function
LED POWER	power supply available
	net weight (semi-automatic tare or preset tare)
	zero (deviation from zero not more than ±0.25 divisions)
	stability
	not used

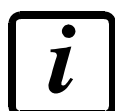

The symbols are activated in sequence within the menus to indicate that the display is not showing a weight.

MENU MAP

Into menus changes are applied right after pressing the **ENTER** key (no further confirmation is required).

SYSTEM PARAMETERS

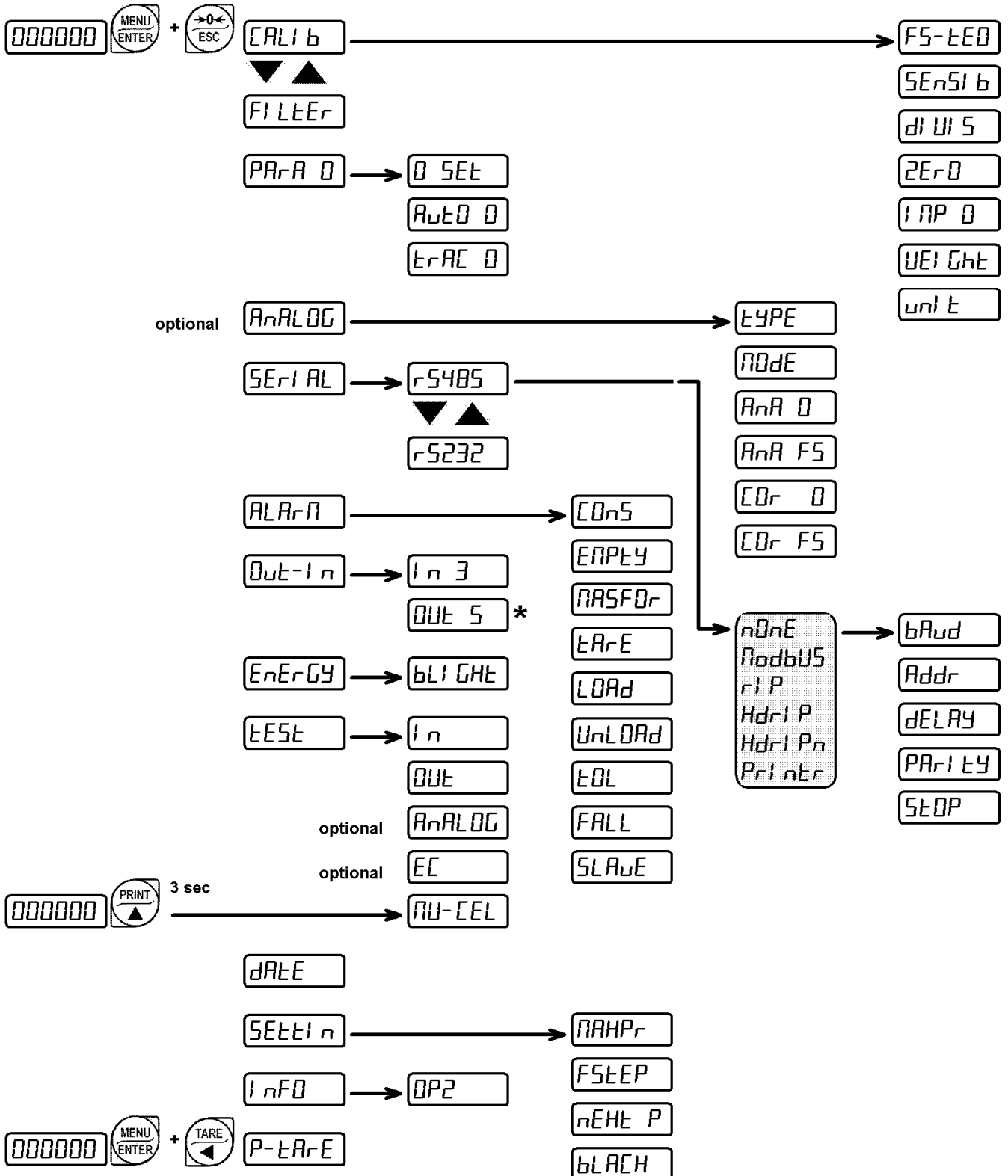

*: only for 3 and 14 products versions

BATCHING CONSTANTS

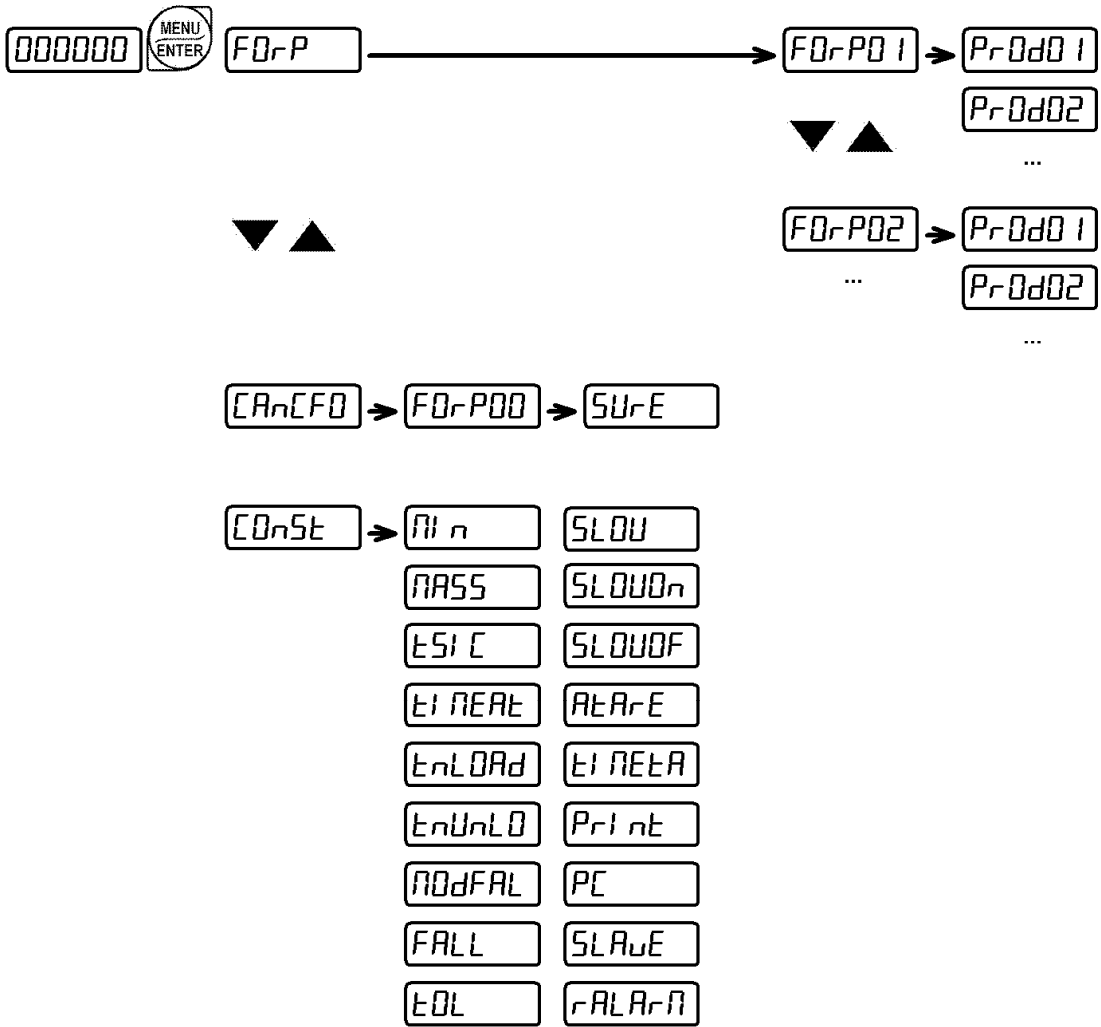

LCD GRAPHIC DISPLAY

BASIC INFORMATION

Upon switch-on, the instrument shows system information on display:

WINX Software: 54 Program: 3 PROD Revision: 1.00.00 Hardware: 238 S.Number: 120012	← ① ← ② ← ③ ← ④ ← ⑤ ← ⑥	1) Instrument model 2) Software code 3) Program type 4) Software version 5) Hardware code 6) Instrument serial number
--	--	--



These information are required to request technical assistance.

As the start-up sequence is completed, if no error occurs, the instrument shows the main screen:

WDESK-G, WINOX-G

① Instrument or plant name
 ② Next formula to be run
 ③ Current date and time
 ④ Unit of measure
 ⑤ System status
 ⑥ Gross weight
 ⑦ LCD display configuration menu
 ⑧ System information display (hold pressed)





WINOX-2G

① Instrument or plant name
 ② Next formula to be run
 ③ Current date and time
 ④ Unit of measure
 ⑤ System status
 ⑥ Gross weight
 ⑦ LCD display configuration menu
 ⑧ System information display (hold pressed)
 ⑨ Scale
 ⑩ Weight value (net/gross)
 ⑪ Signalling symbols
 ⑫ Battery charge level (optional)

Scale: graphical display of system load status. To use this information properly, set the maximum weight (see section **MAXIMUM WEIGHT**).

Instrument name: plant name is displayed (if set), otherwise instrument name and identification number are displayed. These information will be included in printouts.

LCD GRAPHIC DISPLAY CONFIGURATION

From the main screen press the  function key to enter the LCD display configuration menu; use the keys , , ,  or the function keys to move within menus:

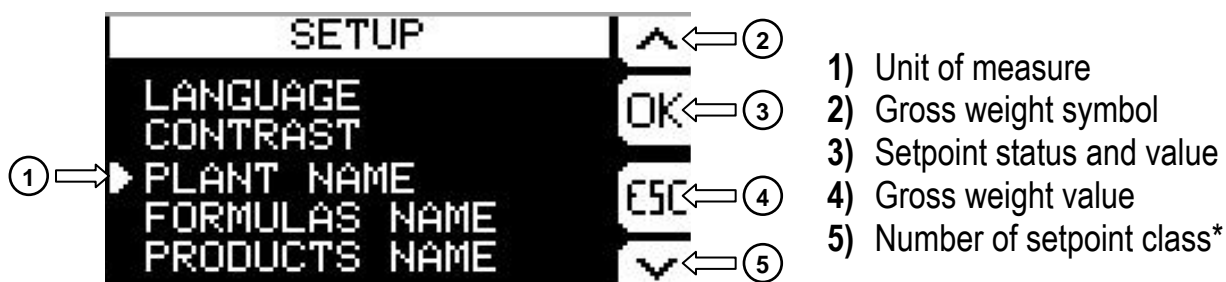

- 1) Unit of measure
- 2) Gross weight symbol
- 3) Setpoint status and value
- 4) Gross weight value
- 5) Number of setpoint class*

- LANGUAGE
- CONTRAST
- PLANT NAME (the name set will be displayed and printed)
- FORMULAS NAME (the name set will be displayed and printed)
- PRODUCTS NAME (the name set will be displayed and printed)
- MSG JOLLY (messages customization, it appears only after having selected the JOLLY language)
- CONSUMPTION (see section **CONSUMPTION**)
- PRODUCTION (see section **PRODUCTION**)
- STOCKS (see section **STOCKS**)
- LOT (the name set will be displayed and printed)

LANGUAGE SETTING

The instrument supports several languages to show LCD display messages.

-  > LANGUAGE
- ITALIANO (default)
 - ENGLISH
 - FRANÇAIS
 - ESPAÑOL
 - JOLLY





“JOLLY” language: allows to customize the text of messages; it can also be loaded onto the instrument (via PC) specific character sets to write messages in other languages.

Selecting the JOLLY language another submenu appears:

-  > MSG JOLLY
- EDIT MSG (edit messages)
 - RESET MSG (restore messages to their default values in english)

CUSTOMIZING MESSAGES OF LCD GRAPHIC DISPLAY

The instrument allows to edit messages in the following way:

-  > PLANT NAME
-  > FORMULAS NAME
-  > PRODUCTS NAME
-  > LOT
-  > MSG JOLLY* > EDIT MSG (only after having selected the JOLLY language)





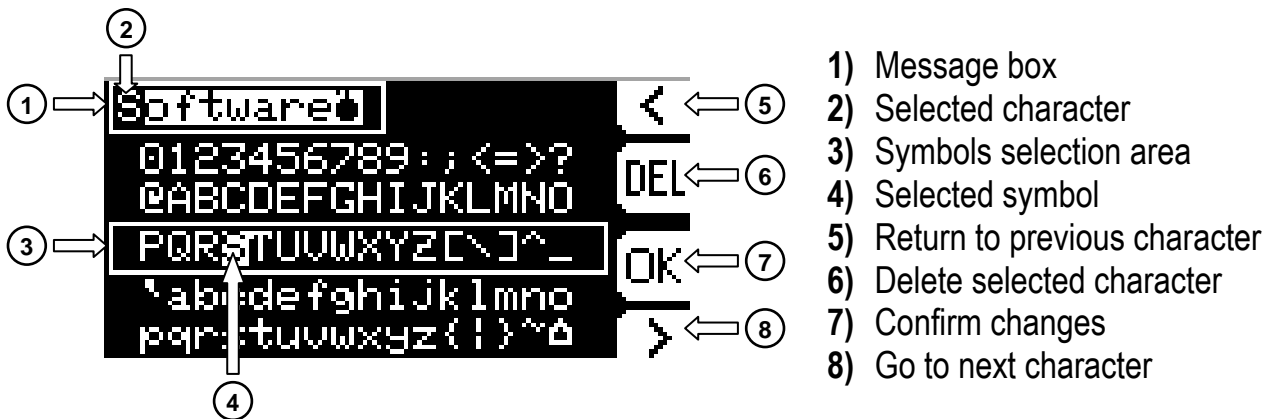

*) allows to edit all display messages

Select the message to edit, the following screen appears:



Use the alphanumeric keys to enter the required characters.

Symbols selection area: move cursor within the symbols selection area using the following keys:

- Press  or  to move vertically;
- Press  or  to move horizontally;
- Press  to confirm selected symbol and go to next character;
- Press  to cancel changes and return to previous screen;

Selected character: the character currently being edited is indicated by the blinking cursor inside the message box;

Selected symbol: the currently selected symbol is indicated by the blinking cursor inside the symbols selection area.

INSTRUMENT COMMISSIONING

To turn on the instrument press **ON**. To turn it off press **OFF** for about 3 seconds: when **OFF** appears release the key.

After a blackout the instrument DOES NOT come on again automatically, you have to press **ON**.

To guarantee an automatic restart after a blackout, disable the ON key (see section **AFTER A BLACKOUT**).

Upon switch-on, the display shows in sequence:

- **111111** → **999999** (ONLY in case of approved program);
- instrument model (e.g.: **Ud5H** or **U1 nH**);
- **SU** followed by the software code (e.g.: **SU 22**);
- program type: **bASE** (base); **LORd**; **UnLORd**; **3PrOd**; **6PrOd**; **14PrOd**; **NULLt** (no active program);
- **r** followed by the software version (e.g.: **r 1.00.00**);
- **HU** followed by the hardware code (e.g.: **HU 238**);
- serial number (e.g.: **130001**);

Check that the display shows the weight and that when loading the load cells there is an increase in weight. If there is not check and verify the connections and correct positioning of the load cells.





- **If the instrument has already been theoretical CALIBRATED** (plant system identification tag present on the instrument and on the cover: load cell's rated data already entered):
 - Reset to zero (see section **TARE WEIGHT ZERO SETTING**)
 - Check the calibration with sample weights and correct the indicated weight if necessary (see section **REAL CALIBRATION (WITH SAMPLE WEIGHTS)**).
- **If the instrument HAS NOT BEEN CALIBRATED** (missing plant system identification tag) proceed with calibration:
 - If load cells data are unknown, follow the procedure in section **REAL CALIBRATION (WITH SAMPLE WEIGHTS)**
 - Enter the rated data of load cells following the procedure given in section **THEORETICAL CALIBRATION**
 - Reset to zero (see section **TARE WEIGHT ZERO SETTING**)
 - Check the calibration with sample weights and correct the indicated weight if necessary (see section **REAL CALIBRATION (WITH SAMPLE WEIGHTS)**).
- If you use the analog output, set the desired analog output type and the full scale value (see section **ANALOG OUTPUT**).
- If you use serial communication, set the related parameters (see section **SERIAL COMMUNICATION SETTING**).
- Set instrument's clock with current date and time (see section **DATE AND TIME SETTING**)

Required settings for the first batching:

- Access the Batching Constants menu and set the minimum weight value (see section **MINIMUM WEIGHT**);
- Access the Formulas menu and set the formula 01 (see section **FORMULAS PROGRAMMING**);
- Start the batching by pressing the **START** button or by closing the START contact

PROGRAMMING OF SYSTEM PARAMETERS

From the weight display, press simultaneously keys **MENU** and **ESC** to access the parameter setting.

- MENU/ENTER**: to enter a menu/confirm the data entry.
-  : to modify the displayed value or menu item.
-  : to select a new figure.
- ESC**: to cancel and return to the previous menu.

THEORETICAL CALIBRATION



This function allows the load cell rated values to be set.

To perform the theoretical calibration set the following parameters in sequence:

- **F5-tE0** (Default: **dEN0**): The **system full scale** is given by one cell capacity multiplied by the number of cells used. Example: 4 cells of 1000 kg → FULL SCALE = 1000 x 4 = 4000. The instrument is supplied with a theoretical full scale value **dEN0** corresponding to 10000. To restore factory values, set 0 as full scale.
- **SEr5I b** (Default: 2.00000 mV/V): **Sensitivity** is a load cell rated parameter expressed in mV/V. Set the average sensitivity value indicated on the load cells. It's possible to set a value between 0.50000 and 7.00000 mV/V. Example of 4-cell system with sensitivity: 2.00100, 2.00150, 2.00200, 2.00250; enter 2.00175, calculated as $(2.00100 + 2.00150 + 2.00200 + 2.00250) / 4$.
- **dI UI 5**: The **division** (resolution) is the minimum weight increment value which can be displayed. It is automatically calculated by the system according to the performed calibration, so that it is equal to 1/10000 of full scale. It can be changed and be variable between 0.0001 and 100 with x1 x2 x5 x10 increments.



- By modifying the theoretical full scale, the sensitivity or divisions, the real calibration is cancelled and the theoretical calibration only is considered valid.
- If the theoretical full scale and the recalculated full scale in real calibration (see section **REAL CALIBRATION (WITH SAMPLE WEIGHTS)**) are equal, this means that the calibration currently in use is theoretical; if they are different, the calibration in use is the real calibration based on sample weights.
- By modifying the theoretical full scale, the sensitivity or divisions and all the system's parameters containing a weight value will be set to default values.

TARE WEIGHT ZERO SETTING



This menu may also be accessed directly from the weight display, holding down the key for 3 seconds.

Perform this procedure after having set the THEORETICAL CALIBRATION data.

Use this function to set to zero the weight of the empty system after commissioning and then later on to compensate zero variations due to the presence of product residues.

Procedure:

- Confirm the message **2Er0** (Zero) by pressing .
- The weight value to be set to zero is displayed. In this phase all of the symbols are flashing.
- Confirming once again, the weight is set to zero (the value is stored to the permanent memory).
- Press to display the value of the total weight reset by the instrument, given by the sum of all of the previous zero settings.

ZERO VALUE MANUAL ENTRY



WARNING: Perform this procedure only if it's not possible to reset the weighed structure tare, for example because it contains product that can not be unloaded.

Set in this parameter the estimated zero value (from 0 to max 999999; default: 0).

REAL CALIBRATION (WITH SAMPLE WEIGHTS)



After having performed the THEORETICAL CALIBRATION and TARE WEIGHT ZERO SETTING, this function allows correct calibration to be done using sample weights of known value and, if necessary, any deviations of the indicated value from the correct value to be corrected.

Load onto the weighing system a sample weight, which must be **at least 50%** of the maximum quantity to be weighed.

By confirming the message **UEI GHE** the flashing value of the weight currently on the system is displayed. In this phase all of the symbols are off. Adjust the value on display by using the arrow keys if necessary. After confirming, the new set weight will appear with all the symbols flashing.

After an additional confirmation, the message **UEI GHE** will be restored and by repeatedly pressing the key the weight will once again be displayed.

Example: for a system of maximum capacity 1000 kg and 1 kg division, two sample weights are available, one of 500 kg and the other one of 300 kg. Load both weights onto the system and correct the indicated weight to 800. Now remove the 300 kg weight, the system must show 500; remove the 500 kg weight, too; the system must read zero. If this does not happen, it means that there is a mechanical problem affecting the system linearity.

WARNING: identify and correct any mechanical problems before repeating the procedure.



- If theoretical full scale and recalculated full scale in real calibration are equal, it means that the theoretical calibration is currently in use; otherwise, the real calibration based on sample weights is in use.
- If the correction made changes the previous full scale for more than 20%, all the parameters with settable weight values are reset to default values.

LINEARISATION OPTION ON MAX 5 POINTS:

It is possible to perform a linearisation of the weight repeating the above-described procedure up to a maximum of five points, using five different sample weights. The procedure ends by pressing the **ESC** button or after entering the fifth value; at this point it will no longer be possible to change the calibration value, but only to perform a new real calibration. To perform a new calibration, should return to the weight display and then re-entering into the calibration menu.

By pressing **▲** after having confirmed the sample weight that has been set, the full scale appears, recalculated according to the value of the maximum sample weight entered and making reference to the cell sensitivity set in the theoretical calibration (*SEnSi b*).

FILTER ON THE WEIGHT



Setting this parameter allows a stable weight display to be obtained.

To increase the effect (weight more stable) increase the value (from 0 to 9, default 4).

As seen in the diagram:

- By confirming the *Fi LtEr* message, the currently programmed filter value is displayed.
- By changing and confirming the value, the weight is displayed and it will be possible to experimentally verify its stability.
- If stability is not satisfactory, confirming brings back the message *Fi LtEr* and the filter may be modified again until an optimum result is achieved.

The filter enables to stabilise a weight as long as its variations are smaller than the corresponding "response time". It is necessary to set this filter according to the type of application and to the full scale value set.

FILTER VALUE	Response times [ms]	Display and serial port refresh frequency [Hz]
0	12	300
1	150	100
2	260	50
3	425	25
4 (default)	850	12.5
5	1700	12.5
6	2500	12.5
7	4000	10
8	6000	10
9	7000	5

ANTI PEAK

When the weight is stable, the anti peak filter removes any sudden disturbances with a maximum duration of 1 second. Confirm the filter on the weight with **ENTER** and select one of the following options:

- **AntiPeak**: anti peak filter enabled (default);
- **AntiPeakF**: anti peak filter disabled.

ZERO PARAMETERS



RESETTABLE WEIGHT SETTING FOR SMALL WEIGHT CHANGES

0 SEt (from 0 to max full scale; default: 300; considered decimals: 300 – 30.0 – 3.00 – 0.300): this parameter indicates the maximum weight value resettable by external contact, keypad or serial protocol.

AUTOMATIC ZERO SETTING AT POWER-ON

Auto 0 (from 0 to max 20% of full scale; default: 0): If at switch-on the weight value is lower than the value set in this parameter and does not exceed the **0 SEt** value, the weight is reset. By setting 0, the function is disabled (**OFF**).

ZERO TRACKING

ERRC 0 (from 1 to 5, default: **n0nE**): When the weight value is stable and, after a second, it deviates from zero by a figure in divisions smaller or equal to the figure in divisions set in this parameter, the weight is set to zero. To disable this function, set **n0nE**.

Example: if the parameter **dl UI 5** is set to 5 and **ERRC 0** is set to 2, the weight will be automatically set to zero for variations smaller than or equal to 10 (**dl UI 5** x **ERRC 0**).

SETTING UNITS OF MEASURE



These are the available units of measure:

- HI LOG:** kilograms
- G:** grams
- t:** tons
- Lb:** pounds
- nEUton:** newtons
- LI tRE:** litres
- bAR:** bars
- AtP:** atmospheres
- PI ECE:** pieces
- nEU-P:** newton metres
- HI LO-P:** kilogram metres
- QTHEr:** other generic units of measure not included in the list

If the print function is enabled, the symbol corresponding to the selected unit of measure will be printed after the measured value.

OUTPUTS AND INPUTS CONFIGURATION



OUTPUTS

3 PRODUCTS version:

- OUTPUTS 1-3: PRODUCTS 1-3.
- OUTPUT 4: CYCLE END.

6 - 14 PRODUCTS version:

- OUTPUTS 1-4: refer to relay modules decoding tables (see wiring diagrams and section **TEST**)

3 - 14 PRODUCTS version:

- OUTPUT 5 (Default = **SLDU**): it's possible to select one of the following functions:
 - **ALARP** (ALARM): the relay is closed when an alarm is present.

- **SLDU** (SLOW): slow function for a precision batching.

6 PRODUCTS VERSION:

- **OUTPUT 5: ALARM** (the relay is closed when an alarm is present)

INPUTS

- **INPUT 1: START**
- **INPUT 2: STOP**
- **INPUT 3 (Default = $\square\square n5$):** It's possible to select one of the following functions:
 - **$nE-L\square$ (NET/GROSS):** by closing this input for no more than one second, it's making an operation of SEMI-AUTOMATIC TARE and the display will show the net weight. To display the gross weight again, hold the NET/GROSS input closed for 3 seconds.
 - **$ZE-\square$ (SEMI-AUTOMATIC ZERO):** by closing the input for no more than one second, the weight is set to zero (see section **SEMI-AUTOMATIC ZERO (WEIGHT ZERO-SETTING FOR SMALL VARIATIONS)**).
 - **$\square\square n5$ (APPROVAL):** the instrument starts the batching only after verifying that this input is closed.

SEMI-AUTOMATIC TARE (NET/GROSS)



THE SEMI-AUTOMATIC TARE OPERATION IS LOST UPON INSTRUMENT POWER-OFF.

To perform a net operation (SEMI-AUTOMATIC TARE), close the NET/GROSS input or press the **TARE** key for less than 3 seconds. The instrument displays the net weight (recently set to zero) preceded by the letter n and the symbol NET will be activated.

To display the gross weight again, keep the NET/GROSS input closed or press **TARE** for 3 seconds.

This operation can be repeated many times by the operator to allow the loading of several products.

Example:

Put the box on the scale, the display shows the box weight; press **TARE**, the display shows the net weight to zero; introduce the product in the box, the display shows the product weight. This operation can be repeated several times.

The semi-automatic tare operation is not allowed if the gross weight is zero.

PRESET TARE (SUBRACTIVE TARE DEVICE)

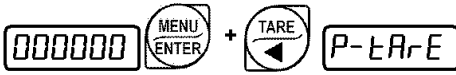

It is possible to manually set a preset tare value to be subtracted from the display value provided that the $P-TARE \leq \text{max weight condition}$ is verified.

By default the instrument shows the last programmed preset tare value: to apply it press and then **ENTER**.

After setting the tare value, going back to the weight display, the display shows the net weight (subtracting the preset tare value) and the NET symbol lights up to show that a tare has been entered. To delete a preset tare and return to gross weight display, hold down **TARE** for about 3 seconds or keep the NET/GROSS input (if any) closed for the same length of time (3 seconds). The preset tare value is set to zero. The NET symbol is turned off when the gross weight is displayed once again.



- IF A SEMI-AUTOMATIC TARE (NET) IS ENTERED, IT IS NOT POSSIBLE TO ACCESS THE ENTER PRESET TARE FUNCTION.
- IF A PRESET TARE IS ENTERED, IT'S STILL POSSIBLE TO ACCESS THE SEMI-AUTOMATIC TARE (NET) FUNCTION. THE TWO DIFFERENT TYPES OF TARE ARE ADDED.



ALL THE SEMI-AUTOMATIC TARE (NET) AND PRESET TARE FUNCTIONS WILL BE LOST WHEN THE INSTRUMENT IS TURNED OFF.

SEMI-AUTOMATIC ZERO (WEIGHT ZERO-SETTING FOR SMALL VARIATIONS)

By closing the SEMI-AUTOMATIC ZERO input, the weight is set to zero; alternatively, by pressing the key for less than 3 seconds, the **SEt** message is displayed for 3 seconds, by pressing **ENTER** the weight is set to zero.

This function is only allowed if the weight is lower than the **SEt** value (see section **RESETTABLE WEIGHT SETTING FOR SMALL WEIGHT CHANGES**), otherwise the alarm **E-----** appears and the weight is not set to zero.

ANALOG OUTPUT(ONLY FOR INSTRUMENTS WHERE THIS OPTION IS AVAILABLE)



- **TYPE**: it selects the analog output type (4÷20 mA, 0÷20 mA, 0÷10 V, 0÷5 V, ±10 V, ±5 V; default: 4÷20 mA).



For the output ±10 V and ±5 V the soldered jumper SW1 must be closed:

- open the instrument;
- locate on the analog board, which is mounted perpendicular to the main board, the soldered jumper SW1 highlighted in the picture below:

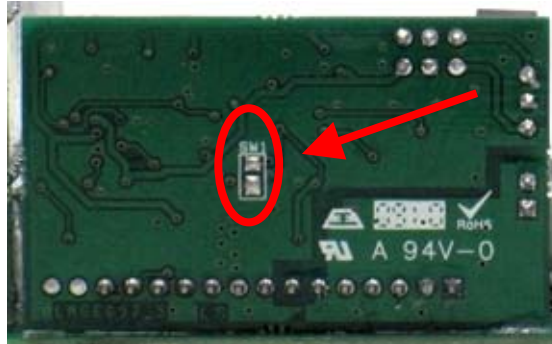

- close the jumper shorting the pads with a drop of tin.
- **MODE**: choice of a weight followed by the analog output: gross (**GROSS**) or net (**NET**). If the net function is not active, the analog output varies according to gross weight.
- **ANA 0**: set the weight value for which you wish to obtain the minimum analog output value.



Only set a value different from zero if you wish to limit the analog output range; for instance: for a full scale value of 10000 kg you require an 4 mA signal at 5000 kg and 20 mA at 10000 kg, in this case, instead of zero, set 5000 kg.

- **ANA FS**: set the weight value for which you wish to obtain the maximum analog output value; it must correspond to the value set in the PLC program (default: calibration full scale). E.g.: if I am using a 4÷20 mA output and in the PLC program I wish to have 20 mA = 8000 kg, I will set the parameter to 8000.
- **CO- 0**: analog output correction to zero: if necessary adjust the analog output, allowing the PLC to indicate 0. The sign “-“ can be set for the last digit on the left. E.g.: if I use a 4÷20 mA output and, with the minimum analog setting, the PLC or tester read 4.1 mA, I must set the parameter to 3.9 to obtain 4.0 on the PLC or tester.
- **CO- FS**: correction of analog output to full scale: if necessary permit modification of the analog output by allowing PLC to indicate the value set in the parameter **ANA FS**. E.g. if I am using a 4÷20 mA output with the analog set to full scale and the PLC or tester reads 19.9 mA, I must set the parameter to 20.1 to get 20.0 on the PLC or tester.

Minimum and maximum values which can be set for zero and full scale corrections:

ANALOG OUTPUT TYPE	Minimum	Maximum
0÷10 V	-0.150	10.200
0÷5 V	-0.150	5.500
±10 V	-10.300	10.200
±5 V	-5.500	5.500
0÷20 mA	-0.200	22.000
4÷20 mA	-0.200	22.000

NOTE: the analog output may also be used in the opposite manner, i.e. the weight setting that corresponds to the analog zero (*ANA 0*) may be greater than the weight set for the analog full scale (*ANA F5*). The analog output will increase towards full scale as the weight decreases; the analog output will decrease as the weight increases.

For example:

ANA 0 = 10000 *ANA F5* = 0 analog output 0÷10 V

Weight = 0 kg analog output = 10 V

Weight = 5000 kg analog output = 5 V

Weight = 10000 kg analog output = 0 V

SERIAL COMMUNICATION SETTING

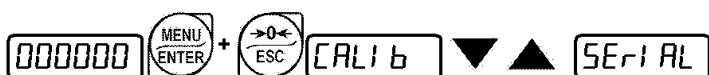

- *r5485 / r5232*: communication port.
 - *nOnE*: it disables any type of communication (default).
 - *ModBUS*: MODBUS-RTU protocol; possible addresses: from 1 to 99 (see Communication protocols manual).
 - *rIP*: continuous weight transmission protocol to RIP5/20/60, RIP50SHA, RIPLD series remote displays; the remote display shows the net weight or gross weight according to its settings (set: *bAUD* = 9600, *PARiTY* = *nOnE*, *StOP* = 1).
 - *HdriP*: continuous weight transmission protocol to RIP675, RIP6125C series remote displays; the remote display shows the net weight or gross weight according to its settings (set: *bAUD* = 9600, *PARiTY* = *nOnE*, *StOP* = 1).
 - *HdriPn*: continuous weight transmission protocol to RIP675, RIP6125C series remote displays (set: *bAUD* = 9600, *PARiTY* = *nOnE*, *StOP* = 1).
When the remote display is set to gross weight:
 - if the instrument displays the gross weight, the remote display shows the gross weight.
 - if the instrument shows the net weight, the remote display shows the net weight alternated with the message *nEt*.
 - *PrIntr*: printer.
 - *bAUD*: transmission speed (2400, 4800, 9600, 19200, 38400, 115200; default: 9600).
 - *Addr*: instrument address (from 1 to 99; default: 1).
 - *dELAY*: delay in milliseconds which elapses before the instrument replies (from 0 to 200 ms; default: 0).
 - *PARiTY*:
 - *nOnE*: no parity (default).
 - *EUEn*: even parity.
 - *Odd*: odd parity.
 - *StOP*: stop bit (1 – 2; default: 1).
 - *ENPEY*: number of blank lines between one printout and the next.
 - *HEAdEr*: printing of custom heading from PC (*YES* – *nD*; default: *nD*).
 - *PrENd*: connected printer type:
 - *P190*
 - *StAUP*
 - *StAUt*
 - *GEriC* (generic serial printer)



For more information about protocols and methods of communication, request the proper manual to technical assistance.

RS232 SERIAL COMMUNICATION

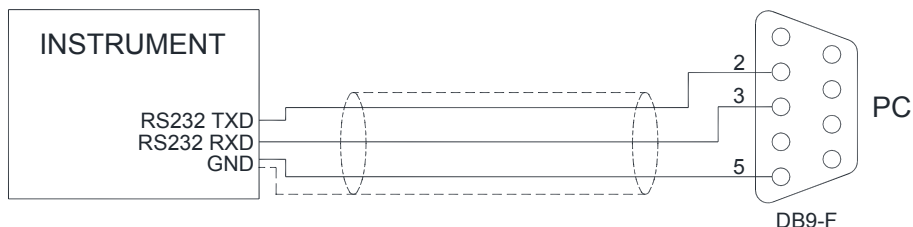

RS485 SERIAL COMMUNICATION

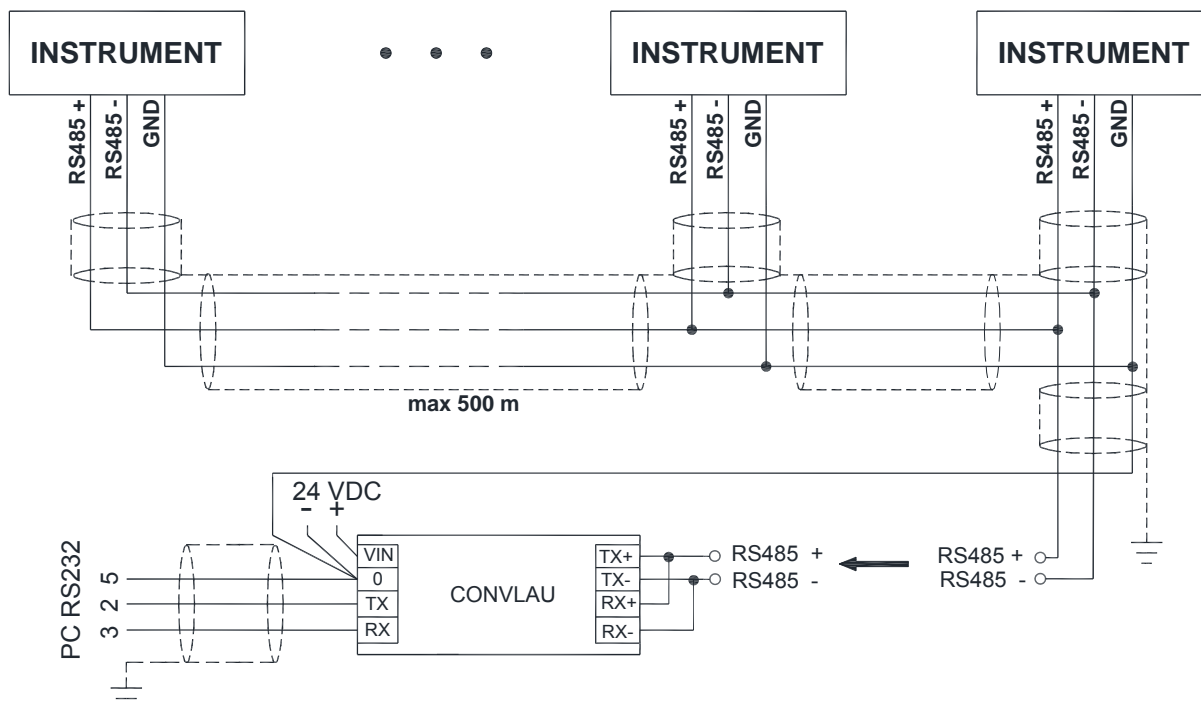

If the RS485 network exceeds 100 metres in length or baud-rate over 9600 are used, two terminating resistors are needed at the ends of the network. Two 120 ohm resistors must be connected between the “+” and “-” terminals of the line, on the terminal strip of the furthest instruments. Should there be different instruments or converters, refer to the specific manuals to determine whether it is necessary to connect the above-mentioned resistors.

DIRECT CONNECTION BETWEEN RS485 AND RS232 WITHOUT CONVERTER

Since a two-wire RS485 output may be used directly on the RS-232 input of a PC or remote display, it is possible to implement instrument connection to an RS-232 port in the following manner:

INSTRUMENT	→	RS232
RS485 -	→	RXD
RS485 +	→	GND



This type of connection allows A SINGLE instrument to be used in a ONE WAY mode.

ALARM RELAY CLOSURE



In 3 and 14 products versions it is necessary to set OUT5 = ALARM (see section **OUTPUTS AND INPUTS CONFIGURATION**).

The ALARM relay closing can be enabled or disabled for each of the following alarms: approval contact (*CDnSP*); formula not programmed (*ENPEY*); maximum weight exceeded (*NASFDr*); minimum weight (*EARrE*); no increase in weight (*LOAD*); no decrease in weight (*UNLOAD*); tolerance (*EDL*); fall (*FALL*); the PC did not read the batching data (*SLAJE*).

YES: in presence of alarm, the relay is closed (default)

n0: the relay is not closed even in the presence of alarm.

TEST



- Input Test:

l n: ensure that for each open input *0* is displayed, *l* is displayed when the input is closed.

- Output Test:

0ut: setting *0* ensure that the corresponding output opens. Setting *l* ensure that the corresponding output closes.

Refer to the following tables to activate the relay of various products (only 6 and 14 products versions)

RELE6PROD MODULE

R1	R2	R3	R4	OUTPUTS
l	l	l	0	PROD.1
0	l	l	0	PROD.2
l	0	l	0	PROD.3
0	0	l	0	PROD.4
l	l	0	0	PROD.5
0	l	0	0	PROD.6
l	0	0	0	CYCLE END
X	X	X	l	SLOW

RELE14PROD MODULE

R1	R2	R3	R4	OUTPUTS
0	0	0	l	PROD.7
l	0	0	l	PROD.8
0	l	0	l	PROD.9
l	l	0	l	PROD.10
0	0	l	l	PROD.11
l	0	l	l	PROD.12
0	l	l	l	PROD.13
l	l	l	l	PROD.14

- E/EC Option Test:

EC: It shows the formula selected by the E/EC option, if the option is not present or is not active, the message *EC-Er* is displayed.

- Analog Output Option Test:

ANALOG: It allows the analog signal to range between the minimum and the maximum values starting from the minimum.

PA: current output test.

VOLT: voltage output test.

- **Millivolt Test:**

NU-CEL: displays the load cell response signal in mV with four decimals.

ENERGY SAVING



- **On**: back-lighting on;
- **OFF**: back-lighting off;
- **CHANGE**: back-lighting goes off after about one minute of no activity; pressing a key or a weight change turns it on again.

DATE AND TIME SETTING



Selecting the **DATE** item in the main menu, access is obtained to the date and time display menu. Pressing **ENTER** several times scrolls through days - months – years and hours – minutes; by pressing the keys **◀** and **▶** the figure to change can be selected; by pressing the keys **▲** and **▼** or using the numerical keypad, the figure can be changed; pressing **ENTER** you can confirm and go to the next menu item.

OPERATION SETTINGS



PARAM: maximum number of products and steps selectable in formula (example: if the version in use is the 6 products and the parameter is set to "4", you can set the products from 1 to 4 and at most 4 steps for each formula).

By changing the value, all formulas are deleted.

It is possible to set:

- from 1 to 3 for 3 products version
- from 1 to 6 for 6 products version
- from 1 to 14 for 14 products version

STEP (Default: **no**): formulas setting in variable or fixed steps.

By changing the value, all formulas are deleted.

- **YES**: products and quantities can be set in formulas in the desired order, even repeating several times the same product (VARIABLE STEPS).
- **no**: products batching sequence is not adjustable, only quantities can be set (FIXED STEPS).

nEHL P: Select the switch conditions from the opening of the batched product to the following or to the CYCLE END closing.

- **tI nE** (Default: **YES**): time set in constants (**tI nEHL**).
- **COnd** (Default: **n0**): START input closure or **ENTER** key pressure.
- **StAbLE** (Default: **n0**): stable weight.

bLACH (Default: **nAn**): Select the batching resume mode after a power failure.

- **Aut**: (Automatic) at the power restore, **bLACH** appears for 3 seconds, after which the batching resumes from the point of interruption.
- **nAn**: (Manual) at the power restore **bLACH** appears, press **ENTER** to resume the batching or press **ESC** to stop it.

INFO MENU



OP2: active options are displayed.

PROGRAMMING OF BATCHING CONSTANTS

From weight display press **MENU**, then press **▲** several times until **COnt** is displayed and confirm.

MENU/ENTER: to enter a menu/confirm the data entry.
▲ **▼**: to modify the displayed value or menu item.
◀ **▶**: to select a new figure.
ESC: to cancel and return to the previous menu.

MINIMUM WEIGHT

Min (from 0 to max full scale; default: 10): minimum weight, value at which the scale is considered empty. Batching start is only allowed if the weight is lower than this value, during the unloading phase the CYCLE END contact will be opened when the weight reaches this value and after the safe emptying time is over.

MAXIMUM WEIGHT

MASS (from 0 to max full scale; default: 0): settable and displayable maximum weight. If the displayed weight exceeds the maximum weight by 9 divisions, the **-----** message is displayed; if in the formulas programming the weight value set is greater than this value, the **Error** message is displayed and the value will not be stored. By setting 0, the function is disabled (**OFF**).

SAFE EMPTYING TIME

ESIT (from 0.0 to max 999.9 seconds; default 5.0): time that is necessary for a perfect emptying of the scale. The instrument waits for this time during the unloading phase (CYCLE END closed), after reaching the minimum weight and before opening the CYCLE END contact to obtain a perfect emptying of the scale. By setting 0, the function is disabled (**OFF**).

WAITING TIME

ELPERL (from 0.0 to max 999.9 seconds; default 5.0): time between the end batching of one product and the following one. By setting 0, the function is disabled (**OFF**).

NO PRODUCT LOAD TIME

ENLOAD (from 0.0 to max 999.9 seconds; default: 0.0): this parameter allows the product control

during batching. if there is no product load, the instrument waits for a set duration of time before activating the alarm *LOAD*. By setting 0, the function is disabled (*OFF*).

NO PRODUCT UNLOAD TIME

UnLoad (from 0.0 to max 999.9 seconds; default: 0.0): this parameter allows the product control during the unloading phase (cycle end). If there is no product extraction, the instrument waits for a set duration of time before activating the alarm *UnLoad*. By setting 0, the function is disabled (*OFF*).

WARNING: The control is only actuated after unloading of the product has started (the weight must decrease by at least 10 divisions).

FALL

By FALL it means the correction of the product amount in fall after the batching STOP. This amount is in addition to the product already batched causing inaccuracy. The instrument is able to anticipate the batching STOP, to reduce this uncertainty, with two possible ways:

- AUTOMATIC fall: the instrument automatically calculates the fall;
- MANUAL fall: the instrument applies the fall set by the operator;

WARNING: Setting a value of **WAITING TIME** (*ΕΙ ΠΕΡΕ*) such that the weight is stable at the end of the batching, otherwise the update of the AUTOMATIC fall is not correct.

PODFAL

PODFAL (from 0 to 1; default: 0): it's possible to select the automatic or the manual fall.

- *PODFAL* = 0: MANUAL fall
- *PODFAL* = 1: AUTOMATIC fall

FALL

FALL (from 0 to maximum weight; default: 0): in this parameter it is possible to set the fall value for each product (only if *PODFAL* = 0) or to display and/or to modify the fall value calculated automatically by the instrument (only if *PODFAL* = 1).

TOLERANCE

ΕΩΛ (from 0 to maximum weight; default: 0): Adjustable parameter for each product that defines how much the batched weight value can deviate from the one set in formula. If the batched weight is higher or lower than the amount to be batched, for a value greater than the tolerance, the instrument closes the ALARM contact. Press **ENTER** to continue the batching. Example: if a PRODUCT = 1000 value is set and a TOLERANCE = 100 value is set, the batched weight must not be lower than 900 or higher than 1100 to allow the instrument to continue the batching process. By setting 0, the function is disabled (*OFF*).

SLOW

SLOW (from 0 to maximum weight; default: 0): adjustable parameter for each product. By slow value we mean the value that, when subtracted from the weight set, minus the fall value, starts the batching slow phase (closing the relative contact). If the value set is higher than the weight to be batched, batching will be all in slow phase. By setting 0, the function is disabled (**OFF**).

Esempio: If PRODUCT = 100, SLOW = 15 and FALL = 10, the slow phase starts when the weight reaches 75.

TAPPING FUNCTION

In the event that the batching instrument is not equipped with the speed “slow” it is possible to use this function to slow down the product batching in the final phase (through opening and closing cycles of the PRODUCT contact) and to increase the accuracy. Set in **SLOW** parameter the product amount you want to batch with the tapping function enabled.

SLOW ON

SLOWON (from 0 to max 9.9; default: 0): time in which the PRODUCT relay remains closed during the SLOW phase. By setting 0, the function is disabled (**OFF**).

SLOW OFF

SLOWOFF (from 0 to max 9.9; default: 0): time in which the PRODUCT relay remains open during the SLOW phase. By setting 0, the function is disabled (**OFF**).

AUTOTARE

ARE-E (from 0 to 1; default: 1): autotare enabling (automatic tare at the batching start).

- **0**: autotare disabled (**OFF**).
- **1**: autotare enabled

This operation is possible only if the gross weight is lower than the minimum weight (**MIN**), otherwise the **AREP** alarm message is displayed.

AUTOTARE DELAY

ETEAR (from 0 to max 99.9; default: 0): the instrument waits for this time, after the starting of the formula, before performing the autotare and starting the batching. By setting 0, the function is disabled (**OFF**).

PRINT AT CYCLE END

Print (Default *no*): function enabling to print batching data at cycle end.

- *YES*: print enabled
- *no*: print disabled

CHECKING PC PRESENCE

PC (Default: *no*): check for a PC connected to the instrument.

- *YES*: PC presence check active; the instrument checks for a PC every 10 seconds. If no PC presence is detected, the instrument will display an alarm signal *PC* alternated with the weight value.
- *no*: PC presence check not active.

WARNING: The check is active only if selected the Modbus protocol.

WAITING CONFIRMATION FROM PC (SLAVE)

SLAVE (Default: *no*): waiting for confirmation of record batching data from PC.

- *YES*: check enabled; the instrument waits for the PC to read the batching data, before starting another batching. In case of recording failure, the instrument displays an alarm *SLAVE*.
- *no*: check disabled; at cycle end, the instrument will not wait for data recording on PC before performing another batching.

SWITCHING OF THE ALARM/SLOW RELAY ON WEIGHT

ALARM (from 0 to max full scale; Default: *0*): by setting a value different from zero (*OFF*), the ALARM/SLOW contact does not switch over in case of alarm/slow, but behaves as a SETPOINT contact; the relay closes when the weight reaches the value set in this parameter.

FORMULAS PROGRAMMING

Select the formula that you wish to program. It is possible to set max 99 formulas.

FIXED STEPS ($F5tEP = n0$, see section OPERATION SETTINGS):

It is only possible to set the quantity of product that you wish to batch, products batching sequence is not adjustable.

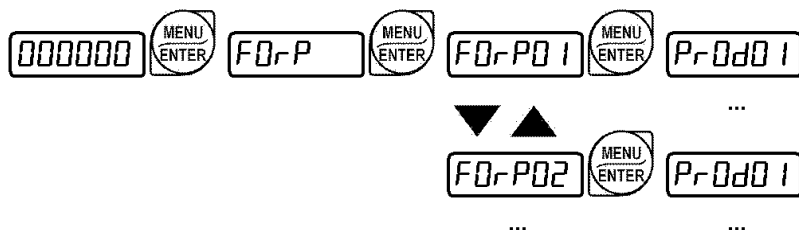

VARIABLE STEPS ($F5tEP = YE5$, see section OPERATION SETTINGS):

It is possible to set the step number, the product number and the quantity of product that you wish to batch.

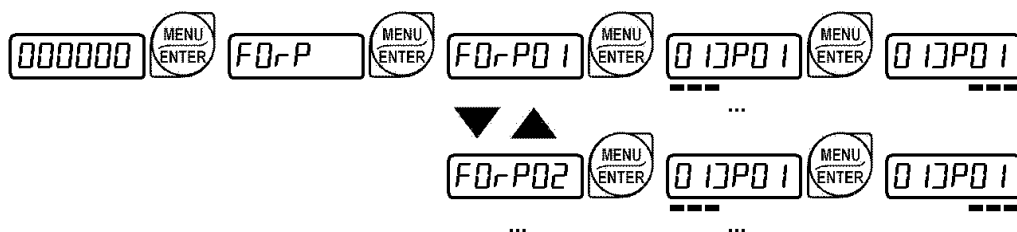

Example: 01P03 (01: step number; P03: product number).

An attempt to set a quantity higher than the maximum weight ($MASS$) set in the batching constants, the *ErrOr* message is displayed.

	STEP	PROD	SET
①	FORMULA :		
②	01	01	100
	02	02	200
③	03	03	250
	04	04	150

- 1) Selected formula
- 2) Step number
- 3) Product number
- 4) Weight values

DELETING FORMULAS

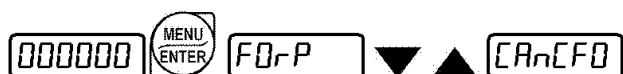

Confirm with **ENTER** the **CArCF0** prompt, to delete one formula enter the formula number, to delete all formulas enter 00 (**F0rP00**), confirm with **ENTER**, you will be prompted to confirm (**SUrE**), to delete confirm again with **ENTER** otherwise press **ESC** to cancel the command.

BATCHING

Note: In case of alarm, the batching may be canceled by pressing the ESC button or by closing the STOP input.

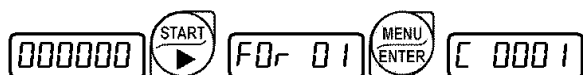

After having selected the formula and set the desired number of batching cycles, the first batching cycle starts as follows:

1. The instrument will ensure that:
 - the formula has been programmed, otherwise it will display the alarm *ENPEY*.
 - the amount set in the formula does not exceed the set maximum weight (*MASS*), otherwise the message *MA5FOr* is displayed.
 - IN3 input (if it is set as Approval) is closed, otherwise the message *COnSP* will be displayed; close the IN3 input to start the batching.
 - Only if *AREArE* is set: the gross weight is lower than the minimum weight (*Min*), otherwise the alarm *AREArE P* is displayed (it is always possible to force the batching start by pressing the ENTER key).
 - Only if consumptions are enabled:
 - If the consumed amount exceeds 999000, the *ExExAL* message appears for a second.
 - If the consumed amount exceeds 999999, it is automatically set to zero.
 - Only if production is enabled:
 - If the batched amount exceeds 9990000, the *PrOdUC* message appears for a second.
 - If the batched amount exceeds 9999999, the amount is automatically set to zero.
2. Once the above listed conditions are met, the batching of first product programmed in formula is started; if the *EnLORd* time is set and the product is not loaded for at least 20 divisions during this time interval, the relative alarm *LORdP* is displayed.
3. The number of the product to be batched (e.g. *P 1*) is displayed for 1 second and then the net weight; the product relay closes;
4. Only if *SLOW* is set: once the value set for that product has been reached, minus the fall and slow values, the SLOW contact closes (if foreseen); if tapping values have been set, the product contact carries out opening and closing cycles according to *SLOWOn* and *SLOWOf* times;
5. Once the value set for that product has been reached, minus any fall value, the product contact is opened interrupting product flow;
6. After the contact opening, the system shows the weight preceded by the letter *A* and waits:
 - Only if *ElNE = YES*: The waiting time has elapsed (*ElNEArE*).
 - Only if *COAnd = YES*: The START input has been closed or the ENTER key has been pressed.
 - Only if *StABLE = YES*: The weight is stable.
7. If the tolerance (*EdL*) is set and the batched quantity is lower than the set quantity minus this value, is made only one attempt of finishing re-start, in order to improve the batching precision. In such a case, the PRODUCT contact is closed and returns to step 5, otherwise the *EdL* alarm appears. If instead, the batched quantity is greater than the set amount plus this value, the *EdL* alarm appears. Press ENTER to cancel the alarm and go on with the batching.
8. Consumption/production/stocks are stored (if enabled);

9. If another product to be batched has been set in the formula, the instrument starts batching the new product and you return to point 3;
10. If there are no more products to be batched in the formula, the system enters the cycle end phase:
 - The CYCLE END contact is closed;
 - The display shows the weight preceded by the letter **E**;
 - Only if $Print = YES$: batching data (with date and time) are printed;
11. At the beginning of the product extraction, if the $tUnload$ time is set and the product is not extracted by at least 20 divisions within this interval of time, the **UnLoad** alarm message will be displayed.
12. The system ends the batching (opening of the CYCLE END contact) only after verifying that:
 - The weight is lower than the minimum weight (Min);
 - The safe emptying time has elapsed (tSf);
13. Only if $SLAVE = YES$: the instrument waits for data recording on PC, before being available for a new batching.

If several batching cycles have been set the instrument starts a new cycle.

BATCHING START FROM EXTERNAL CONTACT

It is possible to select the required formula via an external selector switch. After selecting the formula, close the START external contact for at least 0.5 seconds and, verified the conditions indicated in section **BATCHING**, the instrument will perform the selected formula batching.

If there is no the formula selection switch (E/EC options), the latest formula entered via the keypad will be batched, or it's possible to set the required formula in the following menu: press the **MENU** key for 3 seconds, **FES00** will be displayed, set the required formula number using the arrow keys and confirm with **ENTER**. At batching start, the set formula will be performed. If 00 is set, the latest formula set via keypad will be recalled.



If at the end of the batching, the START contact is closed, the same batching sequence is repeated.

BATCHING START FOR SINGLE PRODUCT WITH AUTOMATIC STOP

This function allows to batch a single product without having to set a special formula.

From weight displaying press **START** and select the *F0r 00* formula; select the product to batch (eg.: *Pr0d 01*) and set its amount; confirm with **ENTER** to perform the batching of the selected product.

The instrument updates the consumptions, production and stock values (if present and enabled) and sends the data to the printer (if enabled).

BATCHING START FOR SINGLE PRODUCT WITH STOP BY KEYBOARD

This function allows to batch a single product, leaving the operator the task to stop the batching.

From weight displaying press **START** and select the *F0r 00* formula; select the product to batch (eg.: *Pr0d 01*) and set its amount to 0; confirm with **ENTER** to close the relay of the selected product and start the batching; press **STOP** to stop it.

The instrument updates the consumptions, production and stock values (if present and enabled) and sends the data to the printer (if enabled).

UNLOADING START WITH AUTOMATIC STOP

This function allows to unload all the scale contents until it reaches the minimum weight.

From weight displaying press **START**, select the *F0r 00* formula and select the *Pr0d 00* product; confirm with **ENTER** to close the CYCLE END relay and start the scale unloading phase; this ends after reaching the minimum weight and after the safe emptying time has elapsed.

DISPLAYING DURING BATCHING

During the batching cycle the display shows the following screen:

WDESK-G, WINOX-G

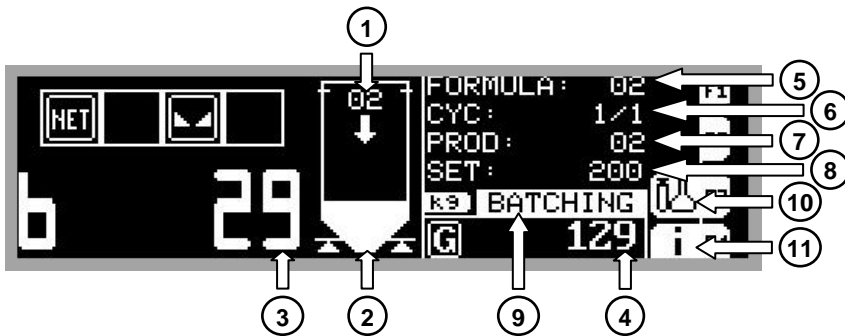

- 1) Loading product number (the arrow indicates that product is loading)
- 2) Product level on the scale
- 3) Batching weight value (net or gross)
- 4) Gross weight value
- 5) Formula number
- 6) Running cycle number
- 7) Product number and name (if set)
- 8) Set value
- 9) System status
- 10) Product detail display
- 11) System information display

WINOX-2G

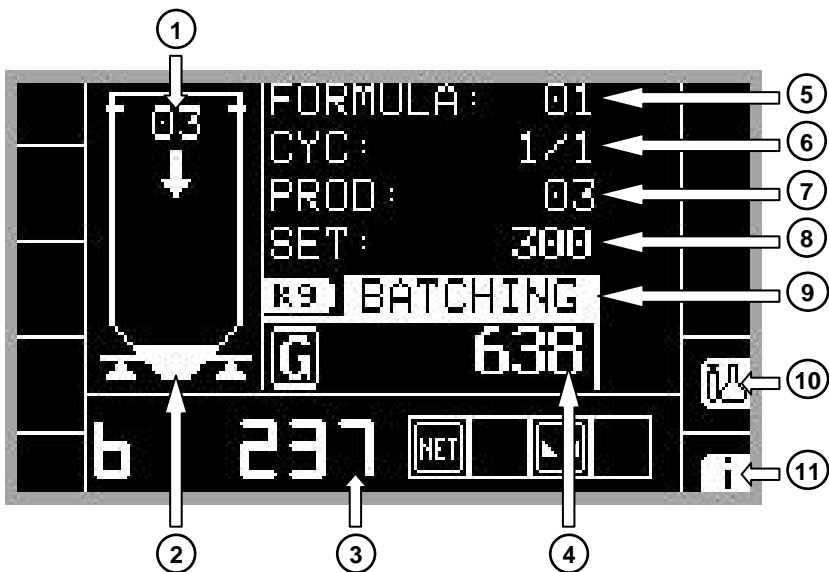

PRODUCT DETAIL DISPLAY

Hold down the  key to show batching product details:



- 1) Formula number
- 2) Running step number
- 3) Product number
- 4) Set value
- 5) Slow value
- 6) Fall value
- 7) Tolerance value

BATCHING STOP

- Open the START contact and close the STOP contact to stop the batching. If the START contact is closed, the *SLP* alarm is displayed.
- To pause the batching at any time, press **STOP**, the *PAUSE* prompt is displayed. Press **ENTER** to resume the batching or press again **STOP** to cancel it completely.

RESUME BATCHING AFTER A POWER CUT

If a blackout occurs during the batching (unloading phase included), when power comes back *BLACH* appears: press **ENTER** to resume batching from the point of interruption, press **ESC** to cancel the batching and return to the weight displaying.



If in constants *BLACH = AUT*, when power comes back *BLACH* appears and after 3 seconds the batching is automatically resumed.

Power failures do not cause any deletion of cycles still to be performed.

TOTALS MANAGEMENT

CONSUMPTION

This feature allows to store consumption of each product since the last deletion.

To enable consumptions management:

- X** > CONSUMPTION
- ENABLE (select YES to enable, NO to disable)

To access consumptions data press **Tot** function key:

- Tot** > CONSUMPTION
- DISPLAY (consumptions display)
- DELETE (consumptions deletion)
- PRINT (consumptions print)

Select **Tot** > CONSUMPTION > DISPLAY to view the consumption list per product:

PR	QTY
1	240
2	477
3	680

- 1) Date and time of last deletion
- 2) Products list
- 3) Selected product
- 4) Consumption

Press **▲** **▼** keys to scroll products list and related consumptions or directly select the product to be displayed: press **ENTER**, set product number (field ③) and confirm.

PRODUCTION

This feature allows to store the quantity of batched product and the number of executed cycles for each formula since the last deletion.

To enable production management:

 > PRODUCTION
- ENABLE (select YES to enable, NO to disable)

To access production data press  function key:



 > PRODUCTION
- DISPLAY (production display)
- DELETE (production deletion)
- PRINT (production print)

Select  > PRODUCTION > DISPLAY to view the production list per formula:



FOR	QTY	CYCLE
1	1397	00
2	00	00
3	00	00

1) Date and time of last deletion
2) Formulas list
3) Selected formula
4) Batched quantity and number of executed cycles

Press   keys to scroll formulas list and related production data or directly select the formula to be displayed: press , set formula number (field ③) and confirm.

STOCKS

This feature allows to manage the stocks for each product.

If STOCKS value falls below MINIMUM STOCK value, the *SEDECH* alarm is displayed.

If at batching start the product quantity to be batched (quantity set in formula multiplied by number of cycles to be run) is higher than STOCKS value, the *SEDECH* alarm is displayed.

To enable stocks management:

 > STOCKS
- ENABLE (select YES to enable, NO to disable)

To access stocks data press **Tot** function key:

- Tot** > STOCKS
- DISPLAY (stocks display and modification)
- DELETE (stocks deletion)
- PRINT (stocks print)

- Tot** > MINIMUM STOCK
- DISPLAY (minimum stocks display and modification)
- DELETE (minimum stocks deletion)
- PRINT (minimum stocks print)

Select **Tot** > STOCKS > DISPLAY to view the list of available stocks per product:

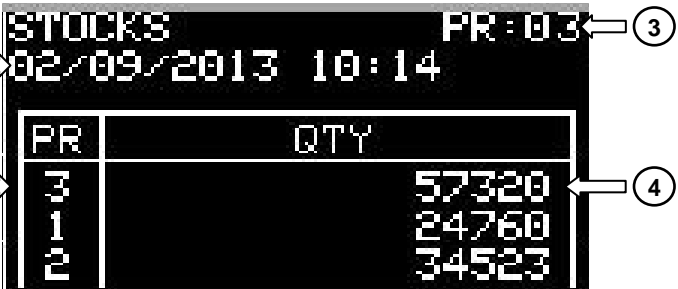

PR	QTY
3	57320
1	24760
2	34523

1) Current date and time
2) Products list
3) Selected product
4) Available quantity

Press **▲** **▼** keys to scroll products list and related available quantities; to edit a product stock press **ENTER**, set product number (field ③) and confirm; the display shows the following screen:

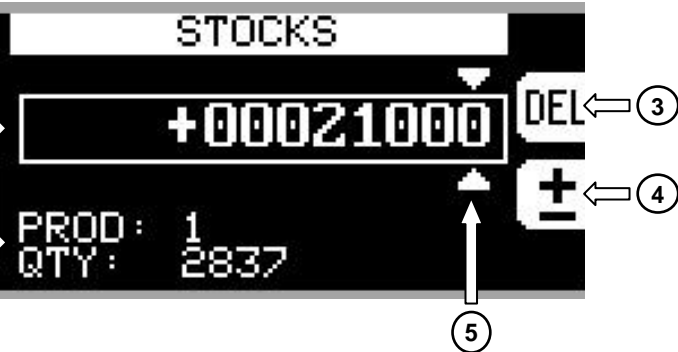

1) Value
2) Additional information
3) Value deletion
4) Value sign change
5) Selected figure

Additional information:

- PROD: product number;
- QTY: quantity currently stored to be modified;

Set the value to add to or subtract from the stock currently stored using the numerical keypad or the keys **▲**, **▼**, **◀** and **▶**; press **ENTER** to confirm.

To view and edit the minimum stocks, select **Tot** > MINIMUM STOCK > DISPLAY and proceed as for stocks.

ALARMS

- ALARM:** (only if $ALARM = 1$) it is displayed if, at batching start, the weight on the scale is higher than the minimum set in constants (MIN). Press **ESC** to return to the weight displaying, press **ENTER** to cancel the alarm and continue with the batching. If the weight comes back below to the minimum set, the batching starts.
- CONSP:** it is displayed when at the batching start the APPROVAL input is open (if the input 3 is set as approval; In 3 = $CONSP$). Close the input to enable batching or cancel it by pressing **ESC**.
- DEL:** it is displayed if at batching end the weight is different from the value set in formula by a value higher than tolerance. Press **ENTER** to cancel the alarm and continue with the batching.
- FALL:** it is displayed if at batching start the fall value is higher than the product quantity to be batched. Press **ESC** to cancel the alarm and the batching.
- EMPTY:** it is displayed if, at batching start, the formula recalled for running is not programmed. Press the key **ESC** to quit.
- FORMER:** it is displayed if, at batching start, the formula recalled for running exceeds the maximum weight. Press the key **ESC** to quit.
- PAUSE:** it means that during batching the **STOP** key has been pressed, temporarily interrupting the cycle; press the **ENTER** key to start it again, or **STOP** to terminate completely the batching.
- BLACH:** it indicates that a power failure occurred during batching: press **ESC** to cancel the batching or press **ENTER** to resume batching again from the point of interruption.
- LOAD:** during the batching it indicates that the product is not loaded. It is automatically cancelled if the product increases. Press **STOP** twice to cancel the batching.
- UNLOAD:** during the unload (Cycle End contact closed) it indicates that the product is not extracted. It is automatically cancelled if the product decreases. Press **STOP** twice to cancel the unload.
- STARTP:** it is displayed for 3 seconds if you try to stop the batching (by pressing twice **STOP** or closing the related input) when the START input is closed. Open the START input to cancel the alarm.
- PARSER:** batching is cancelled. Press **ESC** to quit. If the alarm persists, contact technical assistance.
- ERRUEI G:** it is displayed when there is a weight alarm and it cancels the current batching. Press **ESC** to go back to the weight display and check the alarm.
- ERRCEL:** the load cell is not connected or is incorrectly connected; the load cell signal exceeds 39 mV; the conversion electronics (AD converter) is malfunctioning; the load cell is a 4-wire and there are no jumpers between EX- and REF- and between EX+ and REF+.
- ERRDL:** the weight display exceeds 110% of the full scale.
- ERRAD:** internal instrument converter failure; check load cell connections, if necessary contact technical assistance.
- :** the weight exceeds the maximum weight by 9 divisions.
- ERRDF:** maximum displayable value exceeded (value higher than 999999 or lower than -999999).
- ERR-----:** weight too high: zero setting not possible.

- PAH-PU:** this message appears in the sample weight setting, in real calibration, after the fifth sample weight value has been entered.
- Error:** the value set for the parameter is beyond the permitted values; press **ESC** to quit the setting mode leaving the previous value unchanged. Examples: a number of decimals is selected for full scale which exceeds the instrument's display potential; value above the maximum setting value; the weight value set in sample weight verification does not match the detected mV increase; the analog output correction goes beyond the permitted limits.
- BLDC:** lock active on menu item, keypad or display.
- n0di SP:** It's not possible to display properly the number because is greater than 999999 or less than -999999.
- bAtrtC:** buffer battery low, loss of date and time of Real-Time Clock. Confirm with **ENTER** to continue; leave the instrument on for at least 12 hours to charge the battery, if the alarm persists contact technical assistance.
- dAtEP:** an incorrect date has been detected: go into the related menu to check and correct it.
- CONAnd:** waiting for START closure or **ENTER** key pressure to continue the batching.
- PC:** PC is not connected.
- SLALe:** PC has not read batching data.
- StDCH:** la quantità di prodotto da dosare (quantità programmata in formula per numero di cicli da eseguire) è superiore alla quantità presente nelle scorte. Premere **ENTER** per annullare l'allarme e proseguire con il dosaggio, premere **ESC** per interromperlo.
- StDCHn:** il valore delle scorte è inferiore al valore delle scorte minime. Premere **ENTER** per annullare l'allarme e proseguire con il dosaggio, premere **ESC** per interromperlo.

Serial protocol alarms:

	<i>ErCEL</i>	<i>Er OL</i>	<i>Er Ad</i>	-----	<i>Er OF</i>	t-----
MODE						
Bit LSB	76543210 xxxxxxxx1	76543210 xxxx1xxx	76543210 xxxxxxxx1x	76543210 xxxxx1xx	76543210 On gross: xxx1xxxx On net: xx1xxxxx	The instrument's response to the zero command is a 'value not valid' error (error code 3)
Status Register MODBUS RTU						
RIP *	__O-F__	__O-L__	__O-F__	__O-L__	__O-F__	__O-F__
HDRIP-N	_ERCEL	_ER_OL	_ER_AD	#####	_ER_OF	O__SET

* For RIP remote displays, if the message exceeds 5 digits the display reads -----.

With an alarm the relays open and the analog outputs go to the lowest possible value according to the following table:

RANGE	0÷20 mA	4÷20 mA	0÷5 V	0÷10 V	±10 V	±5 V
Output value	-0.2 mA	3.5 mA	-0.5 V	-0.5 V	0 V	0 V

PRINTING EXAMPLES

If the printer has been set (see section **SERIAL COMMUNICATION SETTING**), from the weight display press the **PRINT** key for less than 3 seconds:

- **UEI GHt**: prints the displayed weight;
- **COhSt**: prints the constants (minimum weight, maximum weight, etc.);
- **FO-P**: prints one or all of the formulas; press **ENTER** to display **FO-P0 I**, set the formula number to be printed or "00" to print them all;

To print consumption, production and stocks data: press **Tot**, enter the desired menu and select **PRINT** (see section **TOTALS MANAGEMENT**).

BATCHING PRINTOUT

Batching in gross weight (**AtArE = 0**)

```
-----  
W--- 14PROD Addr:01  
FORMULA: 01  
CYCLE: 1/ 1  
DATE: 01/10/11 08:30:01
```

```
INIT.WEIGHT 10 kg  
P01 G 301: 300 kg  
P02 N 714: 700 kg  
P05 N 1025: 1000 kg  
TOT G 2040: 2000 kg
```

Batching in net weight (**AtArE = 1**)

```
-----  
W--- 14PROD Addr:01  
FORMULA: 01  
CYCLE: 1/ 1  
DATE: 01/10/11 08:30:01
```

```
TARE 10 kg  
P01 N 301: 300 kg  
P02 N 714: 700 kg  
P05 N 1025: 1000 kg  
TOT G 2050: 2000 kg
```

CONSTANTS PRINTOUT

W--- 14PROD Addr:01
DATE: 01/10/11 08:30:01
CONSTANTS
MIN 10
MASS 0
TIME SIC 5.0
TIME WAIT 5.0
TIME NLOAD 0.0
TIME NUNLOAD 0.0
FALL MANUAL
TIME SLOWON 0.0
TIME SLOWOF 0.0
AUTOTARE YES
PRINT NO
PC NO
SLAVE NO
BLACKOUT MANUAL

PR	FALL	TOLER	SLOW
02	0	0	200
03	52	0	0
06	0	100	0

FORMULA PRINTOUT

W--- 14PROD Addr:01
DATE: 01/10/11 08:30:01
FORMULA: 01
P01 300 kg
P04 400 kg
P07 1000 kg
P11 400 kg

TOTALS PRINTOUT

Minimum stocks values print

W--- 14PROD Addr:01
DATE: 01/10/11 08:30:01
MINIMUM STOCK
P01 100 kg

Stocks values print

W--- 14PROD Addr:01
DATE: 01/10/11 08:30:01
STOCK
P01 8670 kg

Production values print

W--- 14PROD Addr:01
DATE: 01/10/11 08:30:01
PRODUCTION
FOR CYCLE QUANTITY
01 2 784 kg
FROM: 30/09/11 14:14:42

Consumptions values print

W--- 14PROD Addr:01
DATE: 21/12/11 14:18:25
CONSUMPTION
TOTAL 784 kg
FROM: 30/09/11 14:14:42

If consumptions are reset to zero, it will also be printed:

CONSUMPTION ERASED







WEIGHT PRINTOUT

W--- 14PROD Addr:01
DATE: 12/09/11 14:48:12



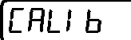

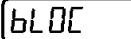

GROSS 1204 kg
NET 831 kg
TARE 373 kg

MENU LOCKING



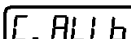

Through this procedure, it's possible to block the access to any menu on the instrument. Select the menu that you wish to lock:

   press  and  simultaneously for 3 seconds, the display shows  (the left point on the text indicates that this menu item is now locked). If the operator tries to enter this menu, the access is denied and the display shows .

MENU UNLOCKING

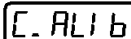

   press  and  simultaneously for 3 seconds, the display shows  (the left point on the text is off to indicate that this menu item is unlocked).

TEMPORARY MENU UNLOCKING

   press  and  simultaneously for 3 seconds: it is now possible to enter and modify all menus including those which are locked. By returning to weight display, the menu lock is restored.

DATA DELETION AND PROGRAM SELECTION



WARNING: operations must only be performed after contacting technical assistance. After each operation the display shows *dOnE*, press  to continue. By pressing  the procedure is cancelled and no changes are made.

Upon instrument power-on hold down the  key until the display shows *PrOG*, then proceed as follows:

CONSTANTS RESTORE (does not erase the calibration): confirm *PrOG*, use arrow keys to select *PA55U*, set code 6935 and confirm.

PROGRAM SELECTION: confirm *P-00* and use the arrow keys to select the desired program:

bA5E: basic program, setpoint management only.

rEuEr: to be used when the loaded weighing system correspond to not loaded cells and vice versa (product increases while weight on load cells actually decreases).

r iP: weight remote display program with setpoint.

L0Ad: monoprodukt loading program.

UnL0Ad: monoprodukt unloading program.

3P-0d: 3 products batching.

6P-0d: 6 products batching.

14P-0d: 14 product batching.

nULeI : no program.

After confirming the choice of the program (except *rEuEr* and *r iP*), the user must choose its approval state among the following possible choices:



n0tLEG: not approved program;

LEGAL: approved program, single division (Dir. 2014/31/EU, art. 1)*;

LEGNi: approved program, multi-interval (Dir. 2014/31/EU, art. 1)*;

LEGNr: approved program, multiple range (Dir. 2014/31/EU, art. 1)*;

- *) Contact technical assistance to request the proper manual and the correct procedures for approval, indicating mandatory hardware code and serial number (see section **INSTRUMENT COMMISSIONING**).

By confirming, the instrument is restored to default and data is erased.



If you do not have a specific manual for the newly set program, you can request it to technical assistance.

KEYPAD OR DISPLAY LOCKING

Press **ESC** immediately followed by **▲** hold them down for about 5 seconds (this operation is also possible via the MODBUS and ASCII protocols):

- *F-EE*: no lock.
- *HEY*: keypad lock: if active, when a key is pressed the message *bLOC* is displayed for 3 seconds.
- *di SP*: keypad and display lock: if active, the keypad is locked and the display shows the instrument model (weight is not displayed); by pressing a key the display shows *bLOC* for 3 seconds.