

Installation and User Manual version 1.00

WDESK-G WINOX-G/2G WTAB-G/2G

Base



CE 2014/30/EU

EN55022:2010 EN61000-6-2:2005 EN61000-6-4:2007

SYSTEM IDENTIFICATION

KEY TO SYMBOLS

Below are the symbols used in the manual to draw the reader's attention:



Warning! Risk of electrocution.



Warning! This operation must be performed by skilled workers.



Read the following indications carefully.



Further information.

GUARANTEE

24 months from the delivery document date. The guarantee covers only defected parts and includes the replacement parts and labour. All shipping and packing costs are paid by the customer. It is possible to have the repair in guarantee on condition that the returned product has not been transformed, damaged or repaired without authorization. No guarantee is applicable on returned products without the original label and/or serial number. No guarantee against misuse.

Batteries: LCC provides 1 year guarantee from the date of delivery note, against material defects or battery manufacturing faults.

Disposal of Waste Equipment by Users in Private Households in the European Union



This symbol on the product or on its packaging indicates that this product must not be disposed of with your other household waste. It is your responsibility to dispose of your waste equipment by handing it over to a designated collection point for the recycling of waste electrical and electronic equipment. The separate collection and recycling of your waste equipment at the time of disposal will help preserve natural resources and protect human health and the environment. For more information about where you can drop off your waste equipment for recycling, please contact your local waste disposal Authority or the equipment retailer.

TABLE OF CONTENTS

USER WARNINGS	1
RECOMMENDATIONS FOR CORRECT INSTALLATION OF WEIGHING INSTRUMENTS .	1
RECOMMENDATIONS FOR CORRECT INSTALLATION OF THE LOAD CELLS.....	1
LOAD CELL INPUT TEST (QUICK ACCESS)	3
LOAD CELL TESTING.....	3
MAIN SPECIFICATIONS OF THE INSTRUMENT	4
BUFFER BATTERY.....	6
AFTER A BLACKOUT	7
TECHNICAL SPECIFICATIONS	8
ELECTRICAL CONNECTIONS.....	9
BASIC INFORMATION.....	9
WIRING DIAGRAM.....	9
<i>CHANGING VOLTAGE 115 VAC / 230 VAC (WDESK)</i>	<i>10</i>
<i>KEY TO P, Q, X TYPE CONNECTORS.....</i>	<i>10</i>
<i>KEY TO D TYPE CONNECTORS.....</i>	<i>11</i>
KEYS AND SYMBOLS FUNCTIONS.....	13
MENU MAP	14
SETPOINT	14
SYSTEM PARAMETERS	14
LCD GRAPHIC DISPLAY.....	15
BASIC INFORMATION.....	15
SETPOINT VISUALIZATION	16
LCD GRAPHIC DISPLAY CONFIGURATION	16
<i>LANGUAGE SETTING.....</i>	<i>17</i>
<i>CUSTOMIZING MESSAGES OF LCD GRAPHIC DISPLAY</i>	<i>18</i>
INSTRUMENT COMMISSIONING.....	19
PROGRAMMING OF SYSTEM PARAMETERS.....	20
THEORETICAL CALIBRATION.....	20
<i>MAXIMUM CAPACITY.....</i>	<i>21</i>
<i>TARE WEIGHT ZERO SETTING.....</i>	<i>21</i>
<i>ZERO VALUE MANUAL ENTRY.....</i>	<i>21</i>
REAL CALIBRATION (WITH SAMPLE WEIGHTS).....	22
FILTER ON THE WEIGHT	23
<i>ANTI PEAK.....</i>	<i>23</i>
ZERO PARAMETERS	24
<i>RESETTABLE WEIGHT SETTING FOR SMALL WEIGHT CHANGES.....</i>	<i>24</i>
<i>AUTOMATIC ZERO SETTING AT POWER-ON</i>	<i>24</i>
<i>ZERO TRACKING.....</i>	<i>24</i>
SETTING UNITS OF MEASURE.....	25
<i>DISPLAY COEFFICIENT</i>	<i>25</i>
OUTPUTS AND INPUTS CONFIGURATION	27

SEMI-AUTOMATIC TARE (NET/GROSS)	28
PRESET TARE (SUBTRACTIVE TARE DEVICE).....	29
SEMI-AUTOMATIC ZERO (WEIGHT ZERO-SETTING FOR SMALL VARIATIONS)	29
PEAK	30
ANALOG OUTPUT(ONLY FOR INSTRUMENTS WHERE THIS OPTION IS AVAILABLE) ..	31
SERIAL COMMUNICATION SETTING.....	32
<i>RS232 SERIAL COMMUNICATION</i>	34
<i>RS485 SERIAL COMMUNICATION</i>	34
<i>DIRECT CONNECTION BETWEEN RS485 AND RS232 WITHOUT CONVERTER</i>	34
PROGRESSIVE WEIGHED VALUES	35
TEST	35
ENERGY SAVING	35
DATE AND TIME SETTING	36
INFO MENU	36
SETPOINT PROGRAMMING.....	36
ITEM DATABASE.....	37
SETTING AND SELECTION OF ITEMS	37
TOTALIZER.....	37
TOTALIZER SETTING	37
USING THE TOTALIZER	38
<i>DISPLAY</i>	38
<i>INCREASING MANUAL TYPE</i>	39
<i>DECREASING MANUAL TYPE</i>	39
<i>AUTOMATIC TYPE</i>	39
<i>AUTOMATIC DELETING</i>	39
TOTALIZER DEACTIVATION.....	39
PIECE COUNTER	40
PIECE COUNTER SETTING.....	40
USING THE PIECE COUNTER.....	41
<i>DISPLAY</i>	41
<i>INCREASING OPERATION</i>	41
<i>DECREASING OPERATION</i>	42
PIECE COUNTER DEACTIVATION	42
STATISTICAL CHECKING OF PREPACKAGES.....	43
CHOOSING A SCALE.....	43
TOLERANCE ZONES AND ACCEPTABILITY CRITERIA.....	44
STATISTICAL CHECK ACTIVATION.....	46
SAMPLE CHECKING PROCEDURE	47
STATISTICAL CHECK DEACTIVATION.....	47
ALARMS.....	47
PRINTING EXAMPLES	49
RESERVED FOR THE INSTALLER	52
MENU LOCKING	52

MENU UNLOCKING..... 52
TEMPORARY MENU UNLOCKING..... 52
DATA DELETION AND PROGRAM SELECTION..... 52
KEYPAD OR DISPLAY LOCKING 53

USER WARNINGS

RECOMMENDATIONS FOR THE PROPER USE OF WEIGHING INSTRUMENT

- Keep away from heat sources and direct sunlight
- Repair the instrument from rain (except special IP versions)
- Do not wash with water jets (except special IP versions)
- Do not dip in water
- Do not spill liquid on the instrument
- Do not use solvents to clean the instrument
- Do not install in areas subject to explosion hazard (except special Atex versions)

RECOMMENDATIONS FOR CORRECT INSTALLATION OF WEIGHING INSTRUMENTS

The terminals indicated on the instrument's wiring diagram to be connected to earth must have the same potential as the weighed structure (same earthing pit or earthing system). If you are unable to ensure this condition, connect with an earthing wire the terminals of the instrument (including the terminal – SUPPLY) to the weighed structure.

The cell cable must be individually led to its panel input and not share a conduit with other cables; connect it directly to the instrument terminal strip without breaking its route with support terminal strips.

Use "RC" filters on the instrument-driven solenoid valve and remote control switch coils.

Avoid inverters in the instrument panel; if inevitable, use special filters for the inverters and separate them with sheet metal partitions.

The panel installer must provide electric protections for the instruments (fuses, door lock switch etc.).

It is advisable to leave the equipment always switched on to prevent the formation of condensation.

MAXIMUM CABLE LENGTHS

- RS485: 1000 metres with AWG24, shielded and twisted cables
- RS232: 15 metres for baud rates up to 19200
- Analog current output: up to 500 metres with 0.5 mm² cable
- Analog voltage output: up to 300 metres with 0.5 mm² cable

RECOMMENDATIONS FOR CORRECT INSTALLATION OF THE LOAD CELLS

INSTALLING LOAD CELLS: The load cells must be placed on rigid, stable in-line structures; it is important to use the mounting modules for load cells to compensate for misalignment of the support surfaces.

PROTECTION OF THE CELL CABLE: Use water-proof sheaths and joints in order to protect the cables of the cells.

MECHANICAL RESTRAINTS (pipes, etc.): When pipes are present, we recommend the use of hoses and flexible couplings with open mouthpieces with rubber protection; in case of hard pipes, place the pipe support or anchor bracket as far as possible from the weighed structure (at a distance at least 40 times the diameter of the pipe).

CONNECTING SEVERAL CELLS IN PARALLEL: Connect several cells in parallel by using - if necessary - a watertight junction box with terminal box. The cell connection extension cables must be shielded, led individually into their piping or conduit and laid as far as possible from the power cables (in case of 4-wire connections, use cables with 4x1 mm² minimum cross-section).

WELDING: Avoid welding with the load cells already installed. If this cannot be avoided, place the welder ground clamp close to the required welding point to prevent sending current through the load cell body.

WINDY CONDITIONS - KNOCKS - VIBRATIONS: The use of weigh modules is strongly recommended for all load cells to compensate for misalignment of the support surfaces. The system designer must ensure that the plant is protected against lateral shifting and tipping relating to: shocks and vibration; windy conditions; seismic conditions in the installation setting; stability of the support structure.

EARTHING THE WEIGHED STRUCTURE: By means of a copper wire with suitable cross-section, connect the cell upper support plate with the lower support plate, then connect all the lower plates to a single earthing system. Electrostatic charges accumulated because of the product rubbing against the pipes and the weighed container walls are discharged to the ground without going through or damaging the load cells. Failure to implement a proper earthing system might not affect the operation of the weighing system; this, however, does not rule out the possibility that the cells and connected instrument may become damaged in the future. It is forbidden to ensure earthing system continuity by using metal parts contained in the weighed structure.

**FAILURE TO FOLLOW THE INSTALLATION RECOMMENDATIONS WILL BE CONSIDERED
A MISUSE OF THE EQUIPMENT**

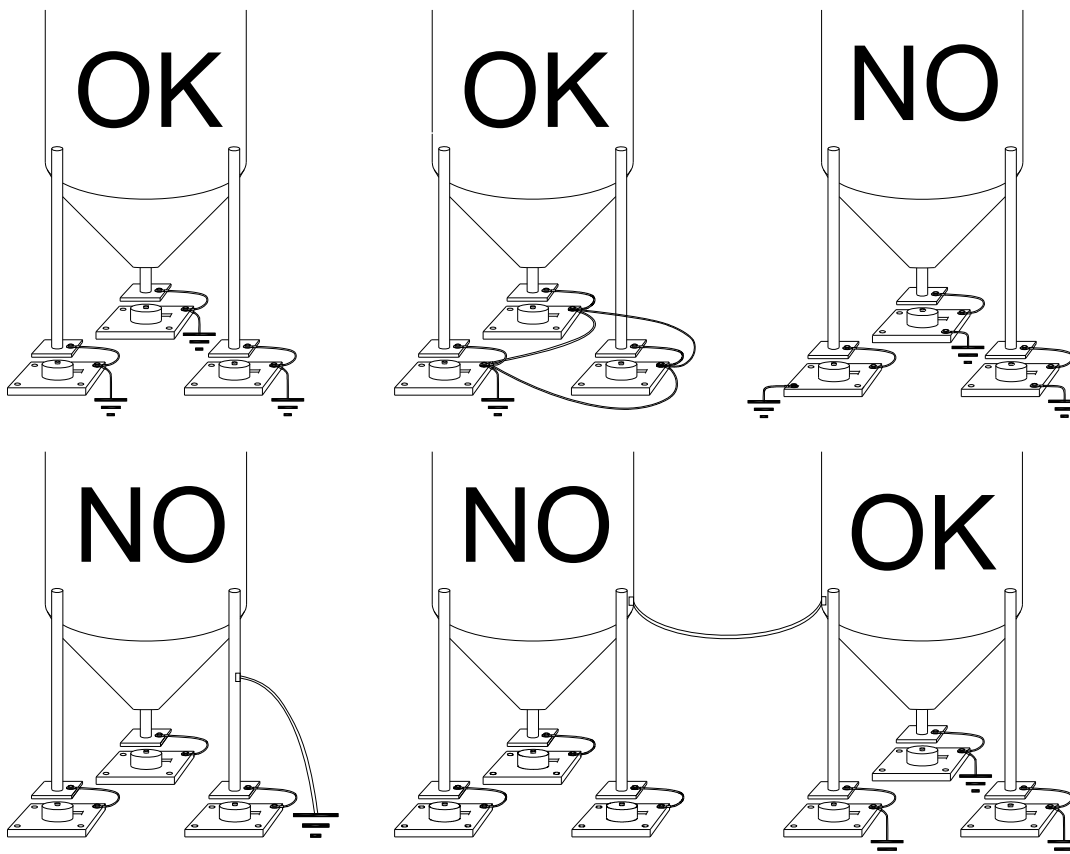

LOAD CELL INPUT TEST (QUICK ACCESS)



From the weight display, press ▲ for 3 seconds; the response signal of the load cells is displayed, expressed in mV with four decimals.

LOAD CELL TESTING

Load cell resistance measurement (use a digital multimeter):

- Disconnect the load cells from the instrument and check that there is no moisture in the cell junction box caused by condensation or water infiltration. If so, drain the system or replace it if necessary.
- The value between the positive signal wire and the negative signal wire must be equal or similar to the one indicated in the load cell data sheet (output resistance).
- The value between the positive excitation wire and the negative excitation wire must be equal or similar to the one indicated in the load cell data sheet (input resistance).
- The insulation value between the shield and any other cell wire and between any other cell wire and the body of the load cell must be higher than 20 Mohm.

Load cell voltage measurement (use a digital multimeter):

- Take out the load cell to be tested from underneath the container, or alternatively, lift the container support.
- Make sure that the excitation of two wires of the load cell connected to the instrument (or amplifier) is 5 Vdc $\pm 3\%$.
- Measure the response signal between the positive and the negative signal wires by directly connecting them to the tester, and make sure that it is comprised between 0 and 0.5 mV.
- Apply load to the cell and make sure that there is a signal increment.

IF ONE OF THE ABOVE CONDITIONS IS NOT MET, PLEASE CONTACT THE TECHNICAL ASSISTANCE SERVICE.

MAIN SPECIFICATIONS OF THE INSTRUMENT

Indicator with 6-wire load cell input installable on table, panel front, wall or column; 6-key membrane keypad with buzzer, real-time clock/calendar with buffer battery.



Two serial ports (RS485 and RS232) for connection to: PC/PLC up to 32 instruments (max 99 with line repeaters) by ASCII or ModBus R.T.U. protocol, remote display, printer. Optional: integrated Profibus DP, DeviceNet, CANopen, Profinet IO, Ethernet/IP, Ethernet TCP/IP, Modbus/TCP output.



Instruments with P, D type connectors: included switching power supply plug 24 V 450 mA, input 100÷240 VAC, 3 meters long cable.







Display:

Model	Display	Resolution	Viewing area
WDESK-G WINOX-G WTAB-G	STN transmissive graphic LCD, white on blue, backlit	240x64 pixel	133x39 mm
WINOX-2G WTAB-2G	STN transmissive graphic LCD, white on blue, backlit	240x128 pixel	128x75 mm

Dimensions:

WDESK	Version	Max. encumbrance	Drilling
	P - PG9 cable gland IP67 protection rating Power supply included	122x226x164 mm (connectors included)	96x186 mm
	Q - Removable terminal strip (panel front) Front panel IP67 protection rating	122x226x152 mm (connectors included)	92x186 mm
	D - D-Sub tray IP40 protection rating Power supply included	122x226x189 mm (connectors included)	96x186 mm

	X - Atex cable gland IP67 Atex  II3GD version (areas 2 -22) IP67 protection rating	122x226x164 mm (connectors included)	96x186 mm
	Wall installation with bracket (can also be installed on table)	122x230x250 mm ca. (bracket included)	

WINOX	Type of connectors	Max. encumbrance	Drilling
	P - PG9 cable gland IP68 protection rating Power supply included	206x286x108 mm (connectors included)	160x248 mm
	Q - Removable terminal strip (panel front) Front panel IP68 protection rating	206x286x96 mm (connectors included)	160x248 mm
	D - D-Sub tray (table) IP40 protection rating Power supply included	206x286x85 mm (connectors included)	
	X - Atex cable gland IP68 Atex  II3GD version (areas 2 -22) IP68 protection rating	206x286x108 mm (connectors included)	160x248 mm
	Wall installation with bracket (can also be installed on table)	206x286x187 mm ca. (bracket included)	

WTAB	Type of connectors	Max. encumbrance	Drilling
	<p>D – D-Sub tray</p> <p>IP40 protection rating</p> <p>Power supply included</p>	<p>315X315X180 mm</p>	

BUFFER BATTERY

The instrument is equipped with an internal battery that allows to keep active the internal clock even in the event of power failure.



At the first start and after long periods of inactivity, leave the instrument on for at least 12 hours to fully charge the battery.

AFTER A BLACKOUT

After a blackout the instrument DOES NOT come on again automatically, you have to press **ON**. To guarantee an automatic restart after a blackout, disable the ON key as follows:

- disconnect power supply and open the instrument;
- identify flat connectors coming from the keypad on the main board;
- extract the 4-pole connector;
- short-circuit the following pins using the unused jumper inside the instrument:
 - WDESK: the two pins further in compared to the main board (see picture to the left);
 - WINOX - WTAB: the two outer pins compared to the main board (see picture to the right);
- connect the 4-pole flat to the two pins still free complying with initial orientation.

WDESK

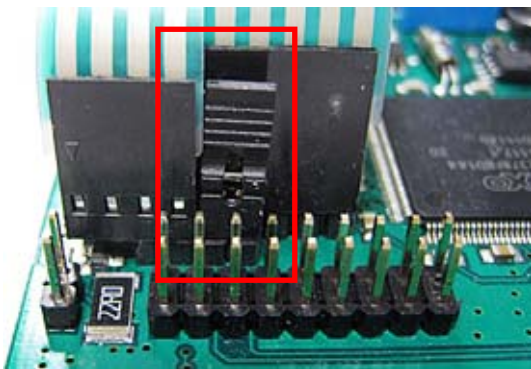

WINOX - WTAB

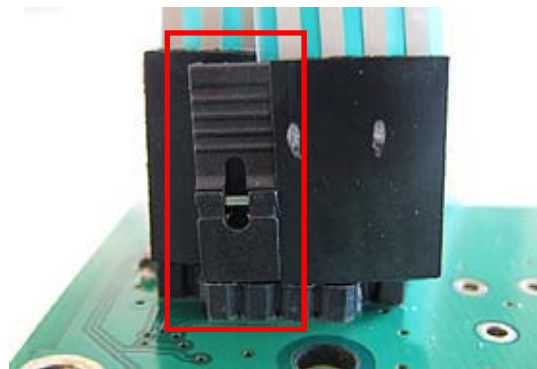

TECHNICAL SPECIFICATIONS

POWER SUPPLY and CONSUMPTION (VDC)	12/24 VDC $\pm 10\%$; 6 W (standard)
POWER SUPPLY and CONSUMPTION (VAC)	115/230 VAC; 50-60 Hz; 6 VA (optional only for WDESK – WINOX-P)
NO. OF LOAD CELLS IN PARALLEL and SUPPLY LINEARITY / ANALOG OUTPUT LINEARITY	max 8 (350 ohm); 5 VDC / 120 mA < 0.01% F.S.; < 0.01% F.S.
THERMAL DRIFT / ANALOG OUTPUT THERMAL DRIFT	< 0.0005% F.S./ $^{\circ}\text{C}$; < 0.003% F.S./ $^{\circ}\text{C}$
A/D CONVERTER	24 bit (16000000 points)
MAX DIVISIONS (with measurement range: ± 10 mV = sens. 2 mV/V)	± 999999
MEASUREMENT RANGE	± 39 mV
MAX SENSITIVITY OF USABLE LOAD CELLS	± 7 mV/V
MAX CONVERSIONS PER SECOND	300 conversions/second
DISPLAY RANGE	± 999999
NO. OF DECIMALS / DISPLAY INCREMENTS	0÷4 / x 1 x 2 x 5 x 10 x 20 x 50 x 100
DIGITAL FILTER / READINGS PER SECOND	0.012÷7 s / 5÷300 Hz
RELAY LOGIC OUTPUTS	N. 5 - max 115 VAC; 150 mA (N. 4 – analog output version)
LOGIC INPUTS	N. 3 - optoisolated 5 - 24 VDC PNP (N. 2 – analog output version)
SERIAL PORTS	RS485, RS232
BAUD RATE	2400, 4800, 9600, 19200, 38400, 115200
HUMIDITY (non condensing)	85%
STORAGE TEMPERATURE	-30 $^{\circ}\text{C}$ +80 $^{\circ}\text{C}$
WORKING TEMPERATURE	-20 $^{\circ}\text{C}$ +60 $^{\circ}\text{C}$
OPTOISOLATED ANALOG OUTPUT (OPTIONAL) 16 bit - 65535 divisions	0÷20 mA; 4÷20 mA (max 300 ohm); 0÷10 V; 0÷5 V; ± 10 V; ± 5 V (min 10 kohm)

	RELAY LOGIC OUTPUTS	N. 5 - max 30 VAC, 60 VDC; 150 mA (N. 4 – analog output version)
	WORKING TEMPERATURE	-20 $^{\circ}\text{C}$ +50 $^{\circ}\text{C}$
	Equipment to be powered by 12-24 Vdc LPS or Class 2 power source.	

ELECTRICAL CONNECTIONS

BASIC INFORMATION

- It is recommended that the power supply negative pole be grounded (WDESK-D, WINOX, WTAB: connect the earthing system to the dedicated external terminal \perp).
- It is possible to supply up to eight 350 ohm load cells or sixteen 700 ohm load cells.
- For 4-wire load cells, make a jumper between EX- and REF- and between EX+ and REF+.
- Connect terminal “- SUPPLY” to the RS485 common of the connected instruments in the event that these receive alternating current input or that they have an optoisolated RS485.
- In case of an RS485 network with several devices it is recommended to activate the 120 ohm termination resistance on the two devices located at the ends of the network, as described in section **RS485 SERIAL CONNECTION**.
- Option **E/EC**: selects 12 groups of 5 setpoint.

WIRING DIAGRAM

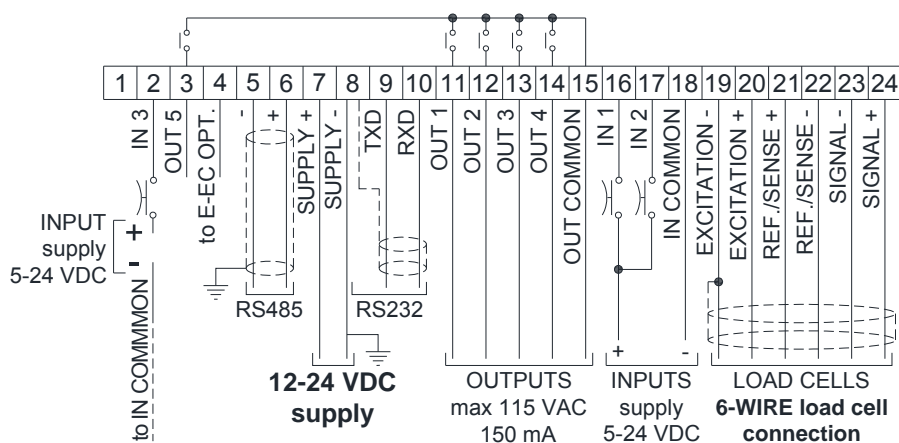

WARNING!
115 V / 230 V OPTIONS
(WDESK-P / WINOX-P)

L	115/230 VAC	
N		
\perp		
7	SUPPLY OUT +	24 VDC OUTPUT
8	SUPPLY OUT -	

(1) ANALOG OUTPUT OPTION

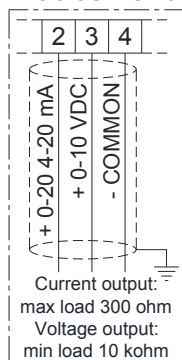

4-WIRE load cell connection

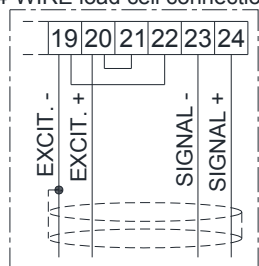

E OPTION

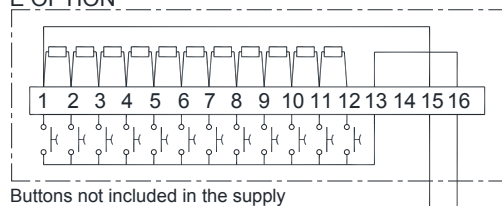

EC OPTION

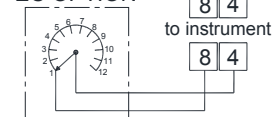

5 outputs: settable setpoint or remote output management via protocol.

3 inputs: settable to have the following functions: **NET/GROSS WEIGHT**, **SEMI-AUTOMATIC ZERO**, **PEAK**, **PRINT** or **REMOTE CONTROL** (see section **OUTPUTS AND INPUTS CONFIGURATION**).

(1) If the analog output is present (ANALOG OUTPUT OPTION) the following is no longer available:

- **IN3** input
- **OUT5** output
- **E/EC** options

WARNING: connect power supply specified on the plate found on the back of the instrument.

In 115 V and 230 V versions, terminals “+ SUPPLY” and “- SUPPLY” generate continuous voltage at 24 Vdc only to be used as power supply for instrument inputs.

CHANGING VOLTAGE 115 VAC / 230 VAC (WDESK)

Access instrument board by removing the six bottom screws and work on the welding side: join the red points using a stiff wire.

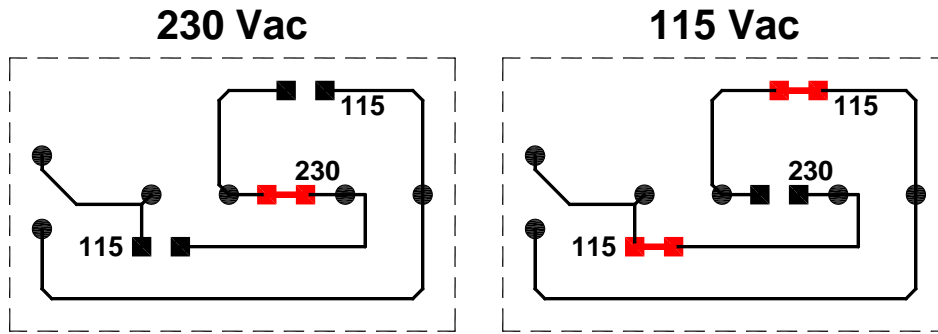

KEY TO P, Q, X TYPE CONNECTORS

Terminal	Signal	Terminal	Signal
1		14	OUTPUT No. 4
2	INPUT No. 3 (+VDC min 5 V max 24 V) <i>otherwise:</i> +ANALOG OUTPUT (0÷20 o 4÷20 mA)	15	OUTPUT COMMON
3	OUTPUT No. 5 <i>otherwise:</i> +ANALOG OUTPUT (0÷10 V)	16	INPUT No. 1 (+VDC min 5 V max 24 V)
4	E/EC OPTION <i>otherwise:</i> -ANALOG OUTPUT COMMON	17	INPUT No. 2 (+VDC min 5 V max 24 V)
5	RS485: -	18	INPUT COMMON (-VDC 0 V)
6	RS485: +	19	-LOAD CELL EXCITATION (-Exc) LOAD CELL SHIELD
7	+SUPPLY (12/24 VDC) 115/230 VAC optional version: +OUTPUT (24 VDC)*	20	+LOAD CELL EXCITATION (+Exc)
8	-SUPPLY (12/24 VDC) RS232, RS485: SHIELD, GND E/EC OPTION: GND 115/230 VAC optional version: -OUTPUT (24 VDC)* RS232, RS485: SHIELD, GND E/EC OPTION: GND	21	+LOAD CELL REF/SENSE
9	RS232: TXD	22	-LOAD CELL REF/SENSE
10	RS232: RXD	23	-LOAD CELL SIGNAL (-Sig)
11	OUTPUT No. 1	24	+LOAD CELL SIGNAL (+Sig)

12	OUTPUT No. 2	L	PHASE (115/230 VAC optional ver.)
13	OUTPUT No. 3	N	NEUTRAL (115/230 VAC optional ver.)
		\perp	GROUND (115/230 VAC optional ver.)

*) Use only as power supply for instrument inputs.



To access the terminal strip on the WDESK instruments with cable glands, you need to remove the bottom of the instrument unscrewing the six screws.

KEY TO D TYPE CONNECTORS















Connector	Pin	Signal	Internal terminal	Internal colour
P1 Power supply		+ SUPPLY (12/24 VDC)	7	red
		- SUPPLY (12/24 VDC)	8	black
D1 Female Load cell	1	-LOAD CELL EXCITATION (-Exc)	19	black
	2	-LOAD CELL REF/SENSE	22	yellow
	3			
	4			
	5	LOAD CELL SHIELD	19	
	6	+LOAD CELL EXCITATION (+Exc)	20	red
	7	+LOAD CELL REF/SENSE	21	blue
	8	-LOAD CELL SIGNAL (-Sig)	23	white
	9	+LOAD CELL SIGNAL (+Sig)	24	green
D3 Male I/O Analog output E/EC option	1	OUTPUT No.1 (max 24 V)	11	yellow
	2	OUTPUT No.2 (max 24 V)	12	blue
	3	OUTPUT No.3 (max 24 V)	13	white
	4	OUTPUT No.4 (max 24 V)	14	green
	5	OUTPUT No. 5 (max 24 V) <i>otherwise:</i> + ANALOG OUTPUT (0÷10 V)	3	orange
	6	OUTPUT COMMON (max 24 V)	15	purple
	7	INPUT No.1 (+VDC min 5 V max 24 V)	16	grey
	8	INPUT No.2 (+VDC min 5 V max 24 V)	17	pink
	9	INPUT No. 3 (+VDC min 5 V max 24 V) <i>otherwise:</i> +ANALOG OUTPUT (0÷20 o 4÷20 mA)	2	brown
	10	INPUT COMMON (-VDC 0 V)	18	white/blue
	11	E/EC OPTION <i>otherwise:</i> -ANALOG OUTPUT COMMON	4	red
	12	E/EC OPTION: GND ANALOG OUTPUT: SHIELD	8	black
	13			

	14			
	15			
D4 Male RS232 serial port	1			
	2	RS232: RXD	10	yellow
	3	RS232: TXD	9	blue
	4			
	5	RS232: SHIELD, GND	8	black
	6			
	7			
	8			
D5 Male RS485 serial port with 24 VDC output	1	+OUTPUT (24 VDC)*	7	red
	2	-OUTPUT (24 VDC)*	8	black
	3			
	4	RS485: +	6	yellow
	5	RS485: SHIELD, GND	8	black
	6	RS485: -	5	blue
	7	RS485: -	5	blue
	8			
	9	RS485: +	6	yellow

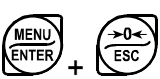



*) Not available if the instrument is battery powered.
 Use only if the instrument is connected to the provided 24 VDC power supply.
 Maximum load: 5 W.

KEYS AND SYMBOLS FUNCTIONS

KEYS

KEY	Short press	Long press (3 s)	Into menus
	Power-on	Power-off	
	Semi-automatic zero	Tare resetting	Cancel or return to previous menu
	Gross → Net	Net → Gross	Select figure to be modified
			Select figure to be modified
	Show date and time on display		Modify figure or go to next menu item
	Print actual weight	mV load cell test	Modify figure or go to previous menu item
	Setting setpoint and hysteresis		Confirm or enter in submenu
	Context-sensitive function keys: see corresponding symbol on LCD display		Context-sensitive function keys: see corresponding symbol on LCD display
	Setting general parameters (press  immediately followed by )		
	Setting preset tare (press  immediately followed by )		

SYMBOLS

SYMBOL	Function
LED POWER	power supply available
	net weight (semi-automatic tare or preset tare)
	zero (deviation from zero not more than ±0.25 divisions)
	stability
	not used

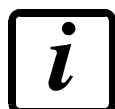

The symbols are activated in sequence within the menus to indicate that the display is not showing a weight.

MENU MAP

Into menus changes are applied right after pressing the **ENTER** key (no further confirmation is required).

SETPOINT

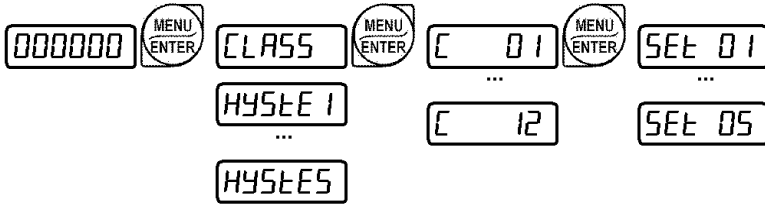

SYSTEM PARAMETERS

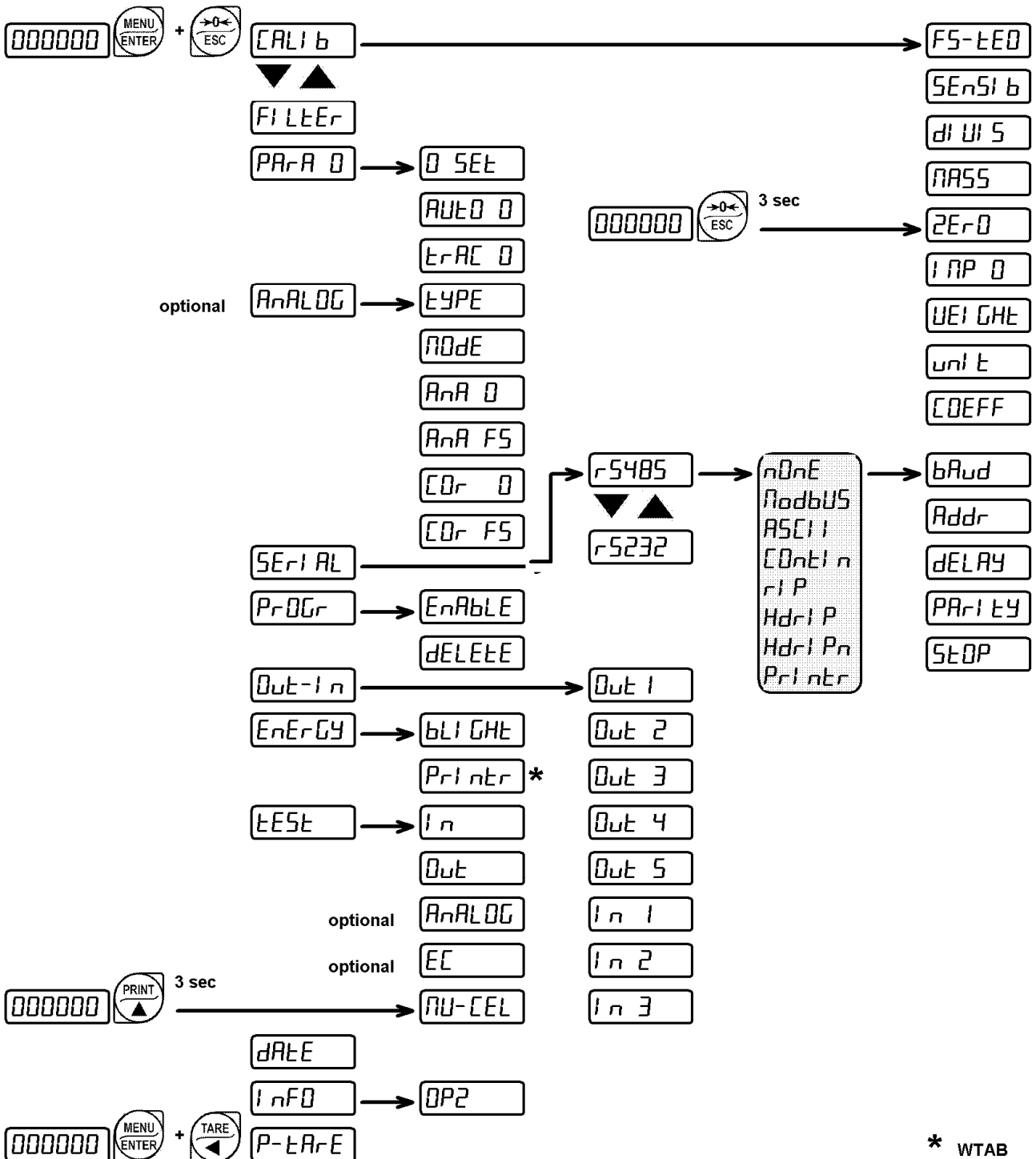

* WTAB

LCD GRAPHIC DISPLAY

BASIC INFORMATION

Upon switch-on, the instrument shows system information on display:

WTAB	← ①	1) Instrument model
Software: 54	← ②	2) Software code
Program: BASE	← ③	3) Programma type
Revision: 1.00.00	← ④	4) Software version
Hardware: 238	← ⑤	5) Hardware code
S.Number: 120012	← ⑥	6) Instrument serial number



These information are required to request technical assistance.

As the start-up sequence is completed, if no error occurs, the instrument shows the main screen:

WDESK-G, WINOX-G, WTAB-G

- 1) Unit of measure
- 2) Gross weight symbol
- 3) Inputs and outputs status
- 4) Gross weight value
- 5) Net weight value
- 6) LCD display configuration menu
- 7) Setpoint display
- 8) Battery charge level (optional)

WINOX-2G, WTAB-2G

Input and output status: if closed the symbol appears, otherwise the symbol appears.

Setpoint visualization: hold down the **SETR** function key to show the setpoint screen; release it to return to previous screen.

SETPOINT VISUALIZATION

From gross weight displaying, hold down the **SETP** function key to show the setpoint screen:

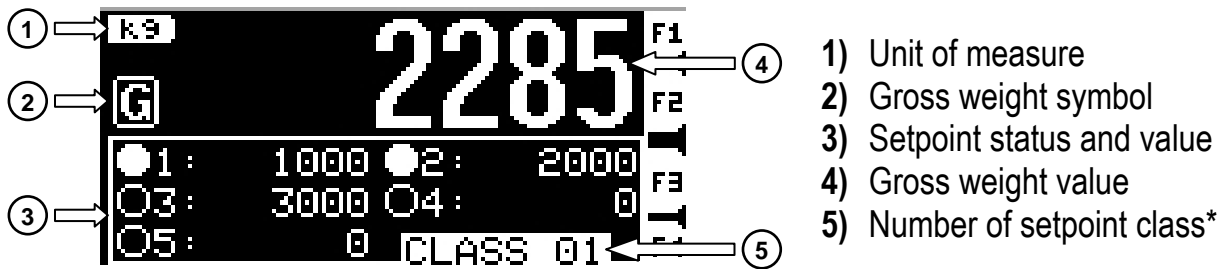

*) Only for instruments equipped with E/EC option.

Setpoint status and value: if weight exceeds setpoint value the symbol is displayed, otherwise the symbol is displayed.

LCD GRAPHIC DISPLAY CONFIGURATION

From the main screen press the function key to enter the LCD display configuration menu; use the keys , , **ENTER** , **ESC** or the function keys to move within menus:

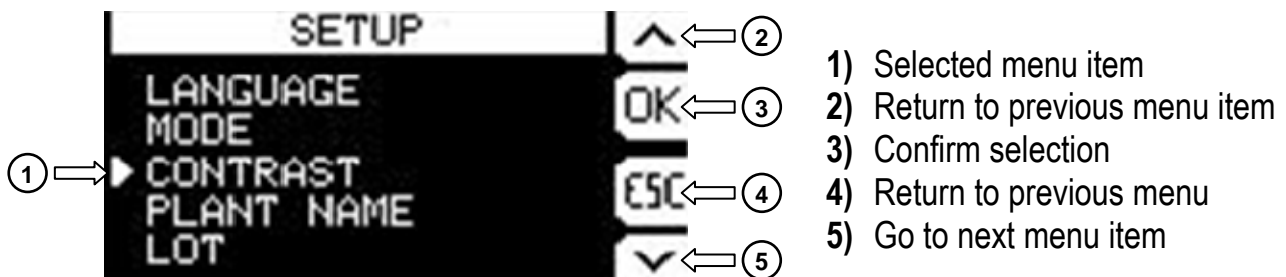

- LANGUAGE
- MODE (it selects the instrument operation mode)
- CONTRAST
- PLANT NAME (the name set will be displayed and printed)
- MSG JOLLY (messages customization, it appears only after having selected the JOLLY language)
- LOT (the name set will be displayed and printed)
- ITEM (99 item database)

LANGUAGE SETTING

The instrument supports several languages to show LCD display messages.

-  > LANGUAGE
- ITALIANO (default)
- ENGLISH
- FRANÇAIS
- ESPAÑOL
- JOLLY



“JOLLY” language: allows to customize the text of messages; it can also be loaded onto the instrument (via PC) specific character sets to write messages in other languages.

Selecting the JOLLY language another submenu appears:

-  > MSG JOLLY
- EDIT MSG (edit messages)
- RESET MSG (restore messages to their default values in english)

CUSTOMIZING MESSAGES OF LCD GRAPHIC DISPLAY

The instrument allows to edit messages in the following way:

-  > PLANT NAME
-  > LOT
-  > MSG JOLLY* > EDIT MSG (only after having selected the JOLLY language)





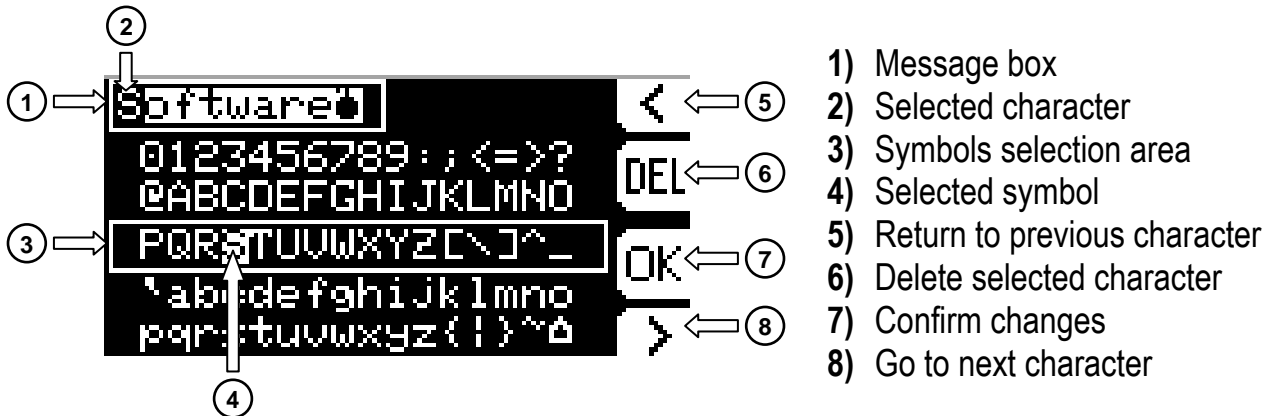

*) allows to edit all display messages

Select the message to edit, the following screen appears:



Use the alphanumeric keys to enter the required characters.

Symbols selection area: move cursor within the symbols selection area using the following keys:

- Press  or  to move vertically;
- Press  or  to move horizontally;
- Press  to confirm selected symbol and go to next character;
- Press  to cancel changes and return to previous screen;

Selected character: the character currently being edited is indicated by the blinking cursor inside the message box;

Selected symbol: the currently selected symbol is indicated by the blinking cursor inside the symbols selection area.

INSTRUMENT COMMISSIONING

To turn on the instrument press **ON**. To turn it off press **OFF** for about 3 seconds: when **OFF** appears release the key.

After a blackout the instrument DOES NOT come on again automatically, you have to press **ON**.

To guarantee an automatic restart after a blackout, disable the ON key (see section **AFTER A BLACKOUT**).

Upon switch-on, the display shows in sequence:





- **111111** → **999999** (ONLY in case of approved program);
- instrument model (e.g.: **Ud5H** or **U1 nH** or **UeAb**);
- **SU** followed by the software code (e.g.: **SU 22**);
- program type: **bASE** (base);
- **r** followed by the software version (e.g.: **r 1.00.00**);
- **HU** followed by the hardware code (e.g.: **HU 238**);
- serial number (e.g.: **13000 1**);

Check that the display shows the weight and that when loading the load cells there is an increase in weight. If there is not check and verify the connections and correct positioning of the load cells.

- **If the instrument has already been theoretical CALIBRATED** (plant system identification tag present on the instrument and on the cover: load cell's rated data already entered):
 - Reset to zero (see section **TARE WEIGHT ZERO SETTING**)
 - Check the calibration with sample weights and correct the indicated weight if necessary (see section **REAL CALIBRATION (WITH SAMPLE WEIGHTS)**).
- **If the instrument HAS NOT BEEN CALIBRATED** (missing plant system identification tag) proceed with calibration:
 - If load cells data are unknown, follow the procedure in section **REAL CALIBRATION (WITH SAMPLE WEIGHTS)**
 - Enter the rated data of load cells following the procedure given in section **THEORETICAL CALIBRATION**
 - Reset to zero (see section **TARE WEIGHT ZERO SETTING**)
 - Check the calibration with sample weights and correct the indicated weight if necessary (see section **REAL CALIBRATION (WITH SAMPLE WEIGHTS)**).
- If you use the analog output, set the desired analog output type and the full scale value (see section **ANALOG OUTPUT**).
- If you use serial communication, set the related parameters (see section **SERIAL COMMUNICATION SETTING**).
- If setpoint are used, set the required weight values and the relevant parameters (see sections **SETPOINT PROGRAMMING** and **OUTPUTS AND INPUTS CONFIGURATION**).
- Set instrument's clock with current date and time (see section **DATE AND TIME SETTING**)

PROGRAMMING OF SYSTEM PARAMETERS

From the weight display, press simultaneously keys **MENU** and **ESC** to access the parameter setting.

- MENU/ENTER**: to enter a menu/confirm the data entry.
-  : to modify the displayed value or menu item.
-  : to select a new figure.
- ESC**: to cancel and return to the previous menu.

THEORETICAL CALIBRATION



This function allows the load cell rated values to be set.

To perform the theoretical calibration set the following parameters in sequence:

- **F5-tE0** (Default: **dE70**): The **system full scale** is given by one cell capacity multiplied by the number of cells used. Example: 4 cells of 1000 kg → FULL SCALE = 1000 x 4 = 4000. The instrument is supplied with a theoretical full scale value **dE70** corresponding to 10000. To restore factory values, set 0 as full scale.
- **SErSI b** (Default: 2.00000 mV/V): **Sensitivity** is a load cell rated parameter expressed in mV/V. Set the average sensitivity value indicated on the load cells. It's possible to set a value between 0.50000 and 7.00000 mV/V. Example of 4-cell system with sensitivity: 2.00100, 2.00150, 2.00200, 2.00250; enter 2.00175, calculated as $(2.00100 + 2.00150 + 2.00200 + 2.00250) / 4$.
- **dI UI 5**: The **division** (resolution) is the minimum weight increment value which can be displayed. It is automatically calculated by the system according to the performed calibration, so that it is equal to 1/10000 of full scale. It can be changed and be variable between 0.0001 and 100 with x1 x2 x5 x10 increments.



- By modifying the theoretical full scale, the sensitivity or divisions, the real calibration is cancelled and the theoretical calibration only is considered valid.
- If the theoretical full scale and the recalculated full scale in real calibration (see section **REAL CALIBRATION (WITH SAMPLE WEIGHTS)**) are equal, this means that the calibration currently in use is theoretical; if they are different, the calibration in use is the real calibration based on sample weights.
- By modifying the theoretical full scale, the sensitivity or divisions and all the system's parameters containing a weight value will be set to default values (setpoint, hysteresis, etc.).

MAXIMUM CAPACITY



MAX: Maximum displayable weight (from 0 to max full scale; default: 0). When the weight exceeds this value by 9 divisions, the display shows ----- . By setting 0, the function is disabled (**OFF**).

TARE WEIGHT ZERO SETTING





This menu may also be accessed directly from the weight display, holding down the  key for 3 seconds.

Perform this procedure after having set the **THEORETICAL CALIBRATION** data.

Use this function to set to zero the weight of the empty system after commissioning and then later on to compensate zero variations due to the presence of product residues.

Procedure:

- Confirm the message **ZErO** (Zero) by pressing .
- The weight value to be set to zero is displayed. In this phase all of the symbols are flashing.
- Confirming once again, the weight is set to zero (the value is stored to the permanent memory).
- Press  to display the value of the total weight reset by the instrument, given by the sum of all of the previous zero settings.

ZERO VALUE MANUAL ENTRY



WARNING: Perform this procedure only if it's not possible to reset the weighed structure tare, for example because it contains product that can not be unloaded.

Set in this parameter the estimated zero value (from 0 to max 999999; default: 0).

REAL CALIBRATION (WITH SAMPLE WEIGHTS)



After having performed the **THEORETICAL CALIBRATION** and **TARE WEIGHT ZERO SETTING**, this function allows correct calibration to be done using sample weights of known value and, if necessary, any deviations of the indicated value from the correct value to be corrected.

Load onto the weighing system a sample weight, which must be **at least 50%** of the maximum quantity to be weighed.

By confirming the message **UEI GHE** the flashing value of the weight currently on the system is displayed. In this phase all of the symbols are off. Adjust the value on display by using the arrow keys if necessary. After confirming, the new set weight will appear with all the symbols flashing.

After an additional confirmation, the message **UEI GHE** will be restored and by repeatedly pressing the key **ESC** the weight will once again be displayed.

Example: for a system of maximum capacity 1000 kg and 1 kg division, two sample weights are available, one of 500 kg and the other one of 300 kg. Load both weights onto the system and correct the indicated weight to 800. Now remove the 300 kg weight, the system must show 500; remove the 500 kg weight too; the system must read zero. If this does not happen, it means that there is a mechanical problem affecting the system linearity.

WARNING: identify and correct any mechanical problems before repeating the procedure.



- If theoretical full scale and recalculated full scale in real calibration are equal, it means that the theoretical calibration is currently in use; otherwise, the real calibration based on sample weights is in use.
- If the correction made changes the previous full scale for more than 20%, all the parameters with settable weight values are reset to default values.

LINEARISATION OPTION ON MAX 5 POINTS:

It is possible to perform a linearisation of the weight repeating the above-described procedure up to a maximum of five points, using five different sample weights. The procedure ends by pressing the **ESC** button or after entering the fifth value; at this point it will no longer be possible to change the calibration value, but only to perform a new real calibration. To perform a new calibration, should return to the weight display and then re-entering into the calibration menu.

By pressing **▲** after having confirmed the sample weight that has been set, the full scale appears, recalculated according to the value of the maximum sample weight entered and making reference to the cell sensitivity set in the theoretical calibration (**SEnSi b**).

FILTER ON THE WEIGHT



Setting this parameter allows a stable weight display to be obtained.

To increase the effect (weight more stable) increase the value (from 0 to 9, default 4).

As seen in the diagram:

- By confirming the *Fi L t E r* message, the currently programmed filter value is displayed.
- By changing and confirming the value, the weight is displayed and it will be possible to experimentally verify its stability.
- If stability is not satisfactory, confirming brings back the message *Fi L t E r* and the filter may be modified again until an optimum result is achieved.

The filter enables to stabilise a weight as long as its variations are smaller than the corresponding “response time”. It is necessary to set this filter according to the type of application and to the full scale value set.

FILTER VALUE	Response times [ms]	Display and serial port refresh frequency [Hz]
0	12	300
1	150	100
2	260	50
3	425	25
4 (default)	850	12.5
5	1700	12.5
6	2500	12.5
7	4000	10
8	6000	10
9	7000	5

ANTI PEAK

When the weight is stable, the anti peak filter removes any sudden disturbances with a maximum duration of 1 second. Confirm the filter on the weight with **ENTER** and select one of the following options:

- *AntPOn*: anti peak filter enabled (default);
- *AntPOF*: anti peak filter disabled.

ZERO PARAMETERS



RESETTABLE WEIGHT SETTING FOR SMALL WEIGHT CHANGES

0 SET (from 0 to max full scale; default: 300; considered decimals: 300 – 30.0 – 3.00 – 0.300): this parameter indicates the maximum weight value resettable by external contact, keypad or serial protocol.

AUTOMATIC ZERO SETTING AT POWER-ON

AUTO 0 (from 0 to max 20% of full scale; default: 0): If at switch-on the weight value is lower than the value set in this parameter and does not exceed the **0 SET** value, the weight is reset. By setting 0, the function is disabled (**OFF**).

ZERO TRACKING

TRAC 0 (from 1 to 5, default: **nONE**): When the weight value is stable and, after a second, it deviates from zero by a figure in divisions smaller or equal to the figure in divisions set in this parameter, the weight is set to zero. To disable this function, set **nONE**.

Example: if the parameter **dl UI 5** is set to 5 and **TRAC 0** is set to 2, the weight will be automatically set to zero for variations smaller than or equal to 10 (**dl UI 5** x **TRAC 0**).

SETTING UNITS OF MEASURE



These are the available units of measure:

- HI LOG: kilograms
- G: grams
- t: tons
- Lb: pounds*
- nEUton: newtons*
- LI t r E: litres*
- bAr: bars*
- Atm: atmospheres*
- PIECE: pieces*
- nEU- Π : newton metres*
- HI LO- Π : kilogram metres*
- Other: other generic units of measure not included in the list*

If the print function is enabled, the symbol corresponding to the selected unit of measure will be printed after the measured value.



For the units marked with * it's possible to set also the display coefficient (parameter **COEFF**, see the related section). To use **COEFF** is necessary to enable it, closing the **COEFF** input (see section **OUTPUTS AND INPUTS CONFIGURATION**).

DISPLAY COEFFICIENT



By setting the coefficient **COEFF** the display is changed accordingly.

If one of the inputs is set to **COEFF** mode (see section **OUTPUTS AND INPUTS CONFIGURATION**) when the input is closed the value will be displayed modified according to the **COEFF** coefficient; when the input is opened the standard weight display will be restored.

COEFF: (max settable value: 99.9999; default: 1.0000) will have different meanings according to the value set in **unit**, i.e. the selected unit of measure. (see section **SETTING UNITS OF MEASURE**).

If the unit of measure chosen is:

- Lb**: pounds, the value set in **COEFF** will be multiplied by the weight value currently displayed;
- nEUton**: newton, the value set in **COEFF** will be multiplied by the weight value currently displayed;
- LI t r E**: litres, in **COEFF** set the specific weight in kg/l, assuming that the system is calibrated in kg;
- bAr**: bar, the value set in **COEFF** will be multiplied by the weight value currently displayed;
- Atm**: atmosphere, the value set in **COEFF** will be multiplied by the weight value currently displayed;

PI ECE: pieces, in **COEFF** set the weight of one piece;

NEU-Π: newton metres, the value set in **COEFF** will be multiplied by the weight value currently displayed;

HI LD-Π: kilogram metres, the value set in **COEFF** will be multiplied by the weight value currently displayed;

DEHER: generic unit of measure not included in the list, the value set in **COEFF** will be multiplied by the weight value currently displayed.



WARNING: All other settings (setpoint, hysteresis, calibration ...) are expressed in weight value. If you want to convert them to the new unit of measurement, perform one of the following procedures for changing the system calibration.

The parameter **COEFF** must remain set to 1.0000.

THEORETICAL CALIBRATION'S CHANGE FOR OTHER UNITS OF MEASURE

Set in the parameter **F5-LED** the F.SCALE value divided by the conversion coefficient from kg to the new unit of measure.

Example: The 4 load cells of 1000 kg are placed under a scale for olive oil, which has a specific gravity of 0.916 kg/l. Setting the F.SCALE = $(4 \times 1000) / 0.916 = 4367$, the system works in liters of olive oil. Also, if you set the parameter **UNIT = LITRE** (see section **SETTING UNITS OF MEASURE**), the system will display and print the symbol "l" instead of "kg".

REAL CALIBRATION'S CHANGE FOR OTHER UNITS OF MEASURE

Load a known quantity of product litres on the scale (equal to at least 50% of the maximum amount that you must weigh) and enter in the parameter **UEI GHE**, the product loaded value in litres. Also, if you set the parameter **UNIT = LITRE** (see section **SETTING UNITS OF MEASURE**), the system will display and print the symbol "l" instead of "kg".

OUTPUTS AND INPUTS CONFIGURATION



OUTPUTS

The outputs are set by default as follows: *OPEN / SET / GROSS / POSNEG / OFF*.

Possible operation modes:

- **OPEN (normally open)**: the relay is de-energised and the contact is open when the weight is lower than the programmed setpoint value; it closes when the weight is higher than or equal to the programmed setpoint value.
- **CLOSE (normally closed)**: the relay is energised and the contact is closed when the weight is lower than the programmed setpoint value; it opens when the weight is higher than or equal to the programmed setpoint value.
- **SET**: the contact will switch on the basis of weight, according to setpoint (see section **SETPOINT PROGRAMMING**).
- **PLC**: the contact will not switch on the basis of weight, but is controlled by remote protocol commands.
- **STABLE**: relay switching occurs when the weight is stable.
- **LINK**: relay switching is linked with the selected item settings.

If the operation mode **SET** is selected, the following options are also active:

- **GROSS**: the contact will switch on the basis of gross weight.
- **NET**: the contact will switch on the basis of net weight (If the net function is not active, the contact will switch on the basis of gross weight).
- **POSNEG**: relay switching occurs for both positive and negative weight values.
- **POS**: relay switching occurs for positive weight values only.
- **NEG**: relay switching occurs for negative weight values only.

By confirming with **ENTER** the setpoint operation can be set to the value 0:

- **OFF**: relay switching will not occur if the setpoint value is 0.
- **On**:
 - setpoint = 0 and switching = **POSNEG**: relay switching occurs when the weight is 0; the relay will switch again when the weight is different from zero, taking hysteresis into account (both for positive and for negative weights).
 - setpoint = 0 and switching = **POS**: relay switching occurs for a weight higher than or equal to 0, the relay will switch again for values below 0, taking hysteresis into account.
 - setpoint = 0 and switching = **NEG**: relay switching occurs for a weight lower than or equal to 0, the relay will switch again for values above 0, taking hysteresis into account.

INPUTS

Default: input 1 = $\Sigma E - 0$ input 2 = $nE - LD$ input 3 = $PEAH$

Possible operation modes:

- $nE - LD$ (NET/GROSS): by closing this input for no more than one second, it's making an operation of SEMI-AUTOMATIC TARE and the display will show the net weight. To display the gross weight again, hold the NET/GROSS input closed for 3 seconds.
- $\Sigma E - 0$: by closing the input for no more than one second, the weight is set to zero (see section **WEIGHT ZERO-SETTING FOR SMALL VARIATIONS (SEMI-AUTOMATIC ZERO)**).
- $PEAH$: keeping the input closed the maximum weight value reached remains on display. Opening the input the current weight is displayed.
- PLC : closing the input no operation is performed, the input status may however be read remotely by way of the communication protocol.
- $COnt n$: closing the input for max one second the weight is transmitted over the serial connection according to the fast continuous transmission protocol only once (**only if $COnt n$ is set in the item $SEr AL$**).
- $COEFF$: when the input is closed the weight is displayed based on the set coefficient (see setting of the units of measure and coefficient), otherwise the weight is displayed.
- $Pr ntr$: when the input is closed the data are sent for printing if in the communication protocol of either serial port the parameter $Pr ntr$ is set.
- $TDAL$: when the input is closed, if an operation mode different from the standard mode is set, the measured value is totalized and data are sent for printing if in the communication protocol of either serial port the parameter set is $Pr ntr$.

SEMI-AUTOMATIC TARE (NET/GROSS)



THE SEMI-AUTOMATIC TARE OPERATION IS LOST UPON INSTRUMENT POWER-OFF.

To perform a net operation (SEMI-AUTOMATIC TARE), close the NET/GROSS input or press the **TARE** key for less than 3 seconds. The instrument displays the net weight (recently set to zero) and the NET symbol will be activated. To display the gross weight again, keep the NET/GROSS input closed or press **TARE** for 3 seconds.

This operation can be repeated many times by the operator to allow the loading of several products.

Example:



Put the box on the scale, the display shows the box weight; press **TARE**, the display shows the net weight to zero; introduce the product in the box, the display shows the product weight. This operation can be repeated several times.

The semi-automatic tare operation is not allowed if the gross weight is zero.

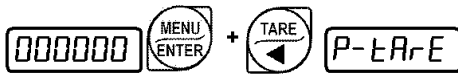
PRESET TARE (SUBTRACTIVE TARE DEVICE)



It is possible to manually set a preset tare value to be subtracted from the display value provided that the $P-TARE \leq \text{max capacity condition}$ is verified.

By default the instrument shows the last programmed preset tare value: to apply it press  and then .

After setting the tare value, going back to the weight display, the display shows the net weight (subtracting the preset tare value) and the NET symbol lights up to show that a tare has been entered. To delete a preset tare and return to gross weight display, hold down  for about 3 seconds or keep the NET/GROSS input (if any) closed for the same length of time (3 seconds). The preset tare value is set to zero. The NET symbol is turned off when the gross weight is displayed once again.





- IF A SEMI-AUTOMATIC TARE (NET) IS ENTERED, IT IS NOT POSSIBLE TO ACCESS THE ENTER PRESET TARE FUNCTION.
- IF A PRESET TARE IS ENTERED, IT'S STILL POSSIBLE TO ACCESS THE SEMI-AUTOMATIC TARE (NET) FUNCTION. THE TWO DIFFERENT TYPES OF TARE ARE ADDED.

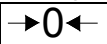

ALL THE SEMI-AUTOMATIC TARE (NET) AND PRESET TARE FUNCTIONS WILL BE LOST WHEN THE INSTRUMENT IS TURNED OFF.

SEMI-AUTOMATIC ZERO (WEIGHT ZERO-SETTING FOR SMALL VARIATIONS)

By closing the SEMI-AUTOMATIC ZERO input, the weight is set to zero; alternatively, by pressing the  key for less than 3 seconds, the SEt message is displayed for 3 seconds, by pressing  the weight is set to zero.

This function is only allowed if the weight is lower than the $0 SEt$ value (see section **RESETTABLE WEIGHT SETTING FOR SMALL WEIGHT CHANGES**), otherwise the alarm $t-----$ appears and the weight is not set to zero.

PEAK

Keep closed PEAK input, the following screen appears:

WDESK-G, WINOX-G, WTAB-G

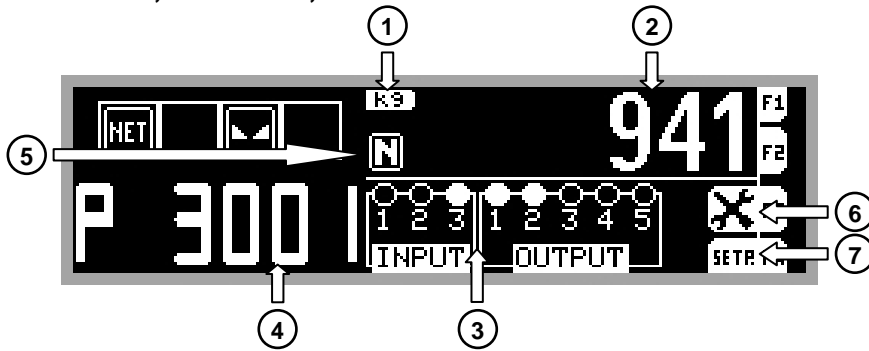

WINOX-2G, WTAB-2G

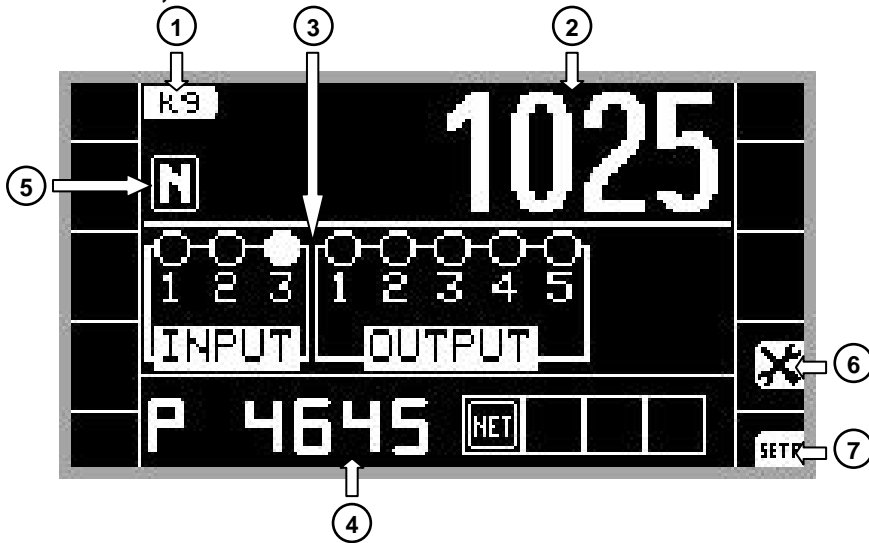

- 1) Unit of measure
- 2) Weight value
- 3) Inputs and outputs status
- 4) Peak value
- 5) Weight type
- 6) LCD display configuration menu
- 7) Setpoint display

By opening the input the current weight is displayed.



If you wish to use this input to view a sudden variation peak, set the FILTER ON THE WEIGHT to 0.

ANALOG OUTPUT(ONLY FOR INSTRUMENTS WHERE THIS OPTION IS AVAILABLE)



- **TYPE:** it selects the analog output type (4÷20 mA, 0÷20 mA, 0÷10 V, 0÷5 V, ±10 V, ±5 V; default: 4÷20 mA).



For the output ±10 V and ±5 V the soldered jumper SW1 must be closed:

- open the instrument;
- locate on the analog board, which is mounted perpendicular to the main board, the soldered jumper SW1 highlighted in the picture below:

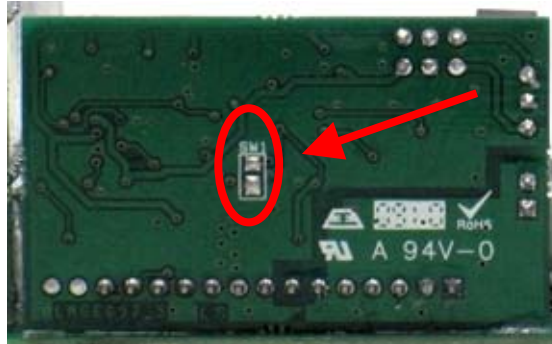

- close the jumper shorting the pads with a drop of tin.

- **MODE:** choice of a weight followed by the analog output: gross (**GROSS**) or net (**NET**). If the net function is not active, the analog output varies according to gross weight.
- **ANA 0:** set the weight value for which you wish to obtain the minimum analog output value.



Only set a value different from zero if you wish to limit the analog output range; for instance: for a full scale value of 10000 kg you require an 4 mA signal at 5000 kg and 20 mA at 10000 kg, in this case, instead of zero, set 5000 kg.

- **ANA FS:** set the weight value for which you wish to obtain the maximum analog output value; it must correspond to the value set in the PLC program (default: calibration full scale). E.g.: if I am using a 4÷20 mA output and in the PLC program I wish to have 20 mA = 8000 kg, I will set the parameter to 8000.
- **CO- 0:** analog output correction to zero: if necessary adjust the analog output, allowing the PLC to indicate 0. The sign “-“ can be set for the last digit on the left. E.g.: if I use a 4÷20 mA output and, with the minimum analog setting, the PLC or tester read 4.1 mA, I must set the parameter to 3.9 to obtain 4.0 on the PLC or tester.
- **CO- FS:** correction of analog output to full scale: if necessary permit modification of the analog output by allowing PLC to indicate the value set in the parameter **ANA FS**. E.g. if I am using a 4÷20 mA output with the analog set to full scale and the PLC or tester reads 19.9 mA, I must set the parameter to 20.1 to get 20.0 on the PLC or tester.

Minimum and maximum values which can be set for zero and full scale corrections:

ANALOG OUTPUT TYPE	Minimum	Maximum
0÷10 V	-0.150	10.200
0÷5 V	-0.150	5.500
±10 V	-10.300	10.200
±5 V	-5.500	5.500
0÷20 mA	-0.200	22.000
4÷20 mA	-0.200	22.000

NOTE: the analog output may also be used in the opposite manner, i.e. the weight setting that corresponds to the analog zero ($ANA\ 0$) may be greater than the weight set for the analog full scale ($ANA\ FS$). The analog output will increase towards full scale as the weight decreases; the analog output will decrease as the weight increases.

For example:

$ANA\ 0 = 10000$ $ANA\ FS = 0$ analog output 0÷10 V

Weight = 0 kg analog output = 10 V

Weight = 5000 kg analog output = 5 V

Weight = 10000 kg analog output = 0 V



From the gross weight display mode, hold the function key **SETA** pressed to display the analog output value expressed in volts or milliamperes.

SERIAL COMMUNICATION SETTING

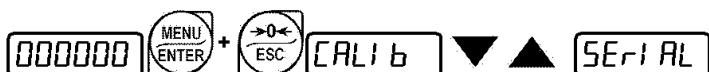

- $r5485 / r5232$: communication port.
 - $n0nE$: it disables any type of communication (default).
 - $ModBUS$: MODBUS-RTU protocol; possible addresses: from 1 to 99 (see Communication protocols manual).
 - $ASCI I$: ASCII bidirectional protocol; possible addresses: from 1 to 99 (see Communication protocols manual).
 - $ModU60$
 - $Mod t d$
 - $COntI n$: continuous weight transmission protocol (see Communication protocols manual), at the frequency set in $HEr t 2$ item (from 10 to 300).
 - $Mod t$ (set: $PARI t Y = n0nE$, $StOP = 1$).
 - $Mod t d$ (set: $PARI t Y = n0nE$, $StOP = 1$).
 - $rI P$: continuous weight transmission protocol to RIP5/20/60, RIP50SHA, RIPLD series remote displays; the remote display shows the net weight or gross weight according to its settings (set: $bAUD = 9600$, $PARI t Y = n0nE$, $StOP = 1$).

- **HdrI P**: continuous weight transmission protocol to RIP675, RIP6125C series remote displays; the remote display shows the net weight or gross weight according to its settings (set: **bAUD** = 9600, **PARITY** = none, **STOP** = 1).
- **HdrI Pn**: continuous weight transmission protocol to RIP675, RIP6125C series remote displays (set: **bAUD** = 9600, **PARITY** = none, **STOP** = 1).

When the remote display is set to gross weight:

- if the instrument displays the gross weight, the remote display shows the gross weight.
- if the instrument shows the net weight, the remote display shows the net weight alternated with the message **nEt**.
- **Printer**: printer.

- **bAUD**: transmission speed (2400, 4800, 9600, 19200, 38400, 115200; default: 9600).
- **Addr**: instrument address (from 1 to 99; default: 1).
- **HErTz**: maximum transmission frequency (10 – 20 – 30 – 40 – 50 – 60 – 70 – 80 – 100 – 200 – 300; default: 10); o be set when the **Cont n** transmission protocol is selected.

Maximum setting frequency (**HErTz**):

- 20 Hz with minimum baud rate 2400 baud.
- 40 Hz with minimum baud rate 4800 baud.
- 80 Hz with minimum baud rate 9600 baud.
- 100 Hz with minimum baud rate 19200 baud.
- 200 Hz with minimum baud rate 38400 baud.
- 300 Hz with minimum baud rate 38400 baud.
- **dELAY**: delay in milliseconds which elapses before the instrument replies (from 0 to 200 ms; default: 0).
- **PARITY**:
 - none: no parity (default).
 - **EVEN**: even parity.
 - **Odd**: odd parity.
- **STOP**: stop bit (1 – 2; default: 1).
- **ENPEY**: number of blank lines between one printout and the next.
- **HEAdEr**: printing of custom heading from PC (**YES** – no; default: no).
- **BARcDE**: BARCODE 39 printout of the following fields:
 - **LOT**: lot name (**YES** – no; default: no);
 - **ITEI**: active item (**YES** – no; default: no);
 - **PrOCr**: progressive weighed value (**YES** – no; default: no);
- **PrEPOd**: connected printer type:
 - **P 190**
 - **STAU P**
 - **STAU t**
 - **PLUSI I** (WTAB ONLY)
 - **GErI C** (generic serial printer)



For more information about protocols and methods of communication, request the proper manual to technical assistance.

RS232 SERIAL COMMUNICATION

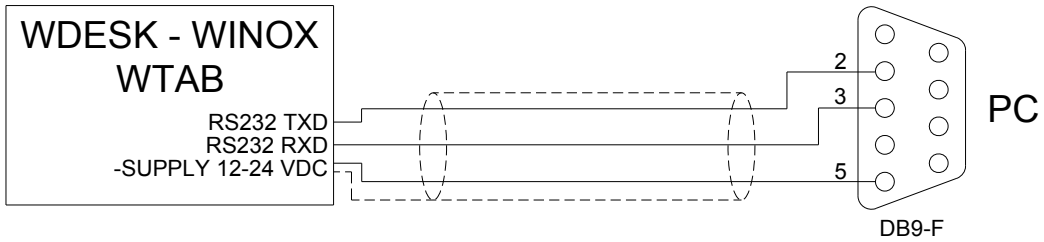

RS485 SERIAL COMMUNICATION

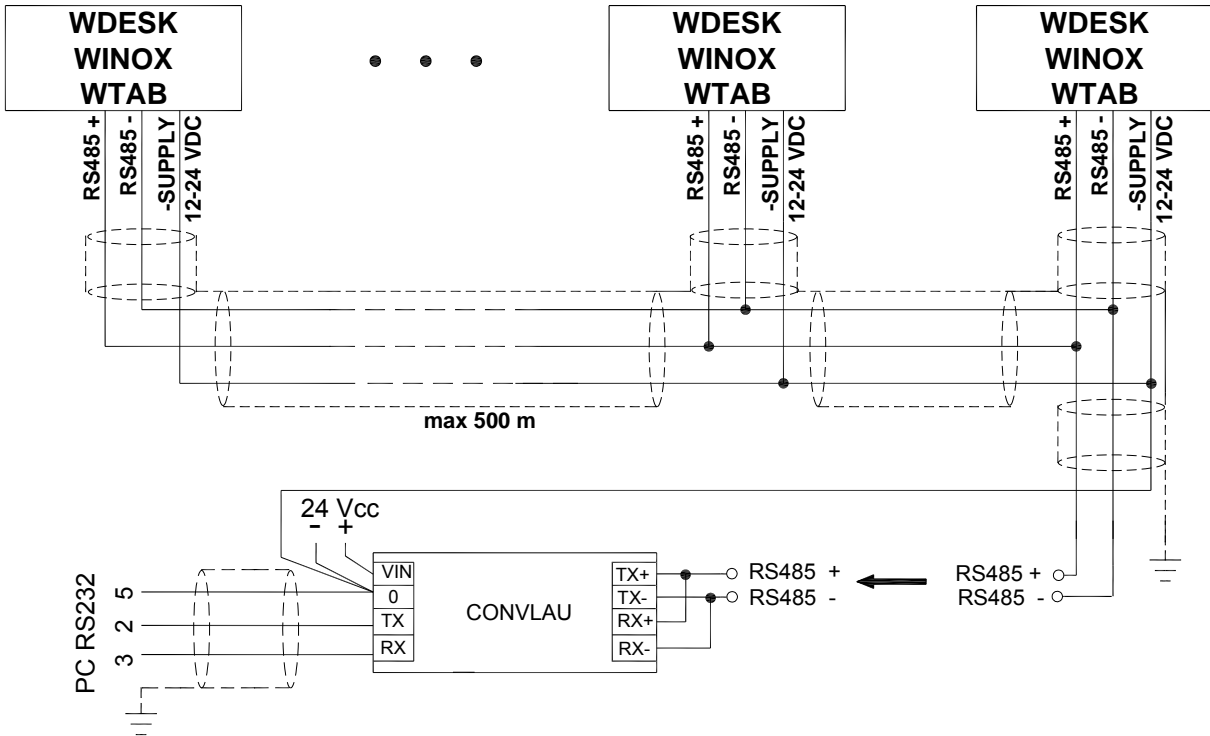

If the RS485 network exceeds 100 metres in length or baud-rate over 9600 are used, two terminating resistors are needed at the ends of the network. Two 120 ohm resistors must be connected between the “+” and “-” terminals of the line, on the terminal strip of the furthest instruments. Should there be different instruments or converters, refer to the specific manuals to determine whether it is necessary to connect the above-mentioned resistors.

DIRECT CONNECTION BETWEEN RS485 AND RS232 WITHOUT CONVERTER

Since a two-wire RS485 output may be used directly on the RS-232 input of a PC or remote display, it is possible to implement instrument connection to an RS-232 port in the following manner:

INSTRUMENT	→	RS232
RS485 -	→	RXD
RS485 +	→	GND



This type of connection allows A SINGLE instrument to be used in a ONE WAY mode.

PROGRESSIVE WEIGHED VALUES



A progressive code may be associated with the obtained weighed values; this code is printed out automatically.

- *EnABLE* (default: *n0*): it activates progressive weighed value association;
- *dELEtE*: it sets the progressive weighed value to zero.

TEST



- **Input Test:**
l n: ensure that for each open input *0* is displayed, *l* is displayed when the input is closed.
- **Output Test:**
0uL: setting *0* ensure that the corresponding output opens. Setting *l* ensure that the corresponding output closes.
- **E/EC Option Test:**
EC: It shows the group number of setpoint selected by the E/EC option, if the option is not present or is not active, the message *EC-Er* is displayed.
- **Analog Output Option Test:**
AnALOG: It allows the analog signal to range between the minimum and the maximum values starting from the minimum.
nA: current output test.
uDLt: voltage output test.
- **Millivolt Test:**
nU-CEL: displays the load cell response signal in mV with four decimals.

ENERGY SAVING



- *0n*: back-lighting on;
- *0FF*: back-lighting off;
- *CHAnGE*: back-lighting goes off after about one minute of no activity; pressing a key or a weight change turns it on again.

WTAB ONLY



- *0n*: the integrated printer is always on;
- *0nPrE*: the integrated printer automatically turns on when printing.

DATE AND TIME SETTING



Selecting the **DATE** item in the main menu, access is obtained to the date and time display menu. Pressing **ENTER** several times scrolls through days - months – years and hours – minutes; by pressing the keys **◀** and **▶** the figure to change can be selected; by pressing the keys **▲** and **▼** or using the numerical keypad, the figure can be changed; pressing **ENTER** you can confirm and go to the next menu item.

INFO MENU

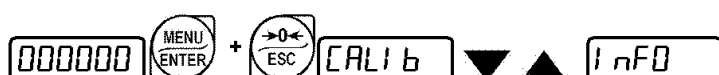

OP2: active options are displayed.

SETPOINT PROGRAMMING

From the weight display, press **MENU** to access the setpoint setting.

MENU/ENTER: to enter a menu/confirm the data entry.
▲ **▼**: to modify the displayed value or menu item.
◀ **▶**: to select a new figure.
ESC: to cancel and return to the previous menu.

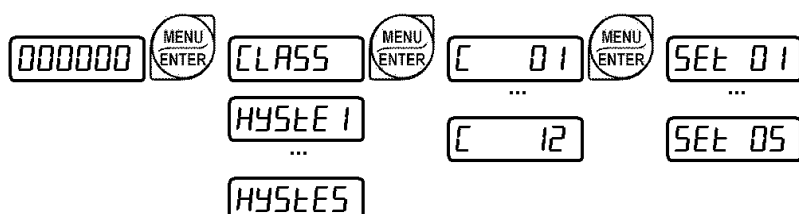

- **CLASS**: if the E/EC option is connected, it is possible to set 12 groups (classes) of different values for the setpoint; otherwise it is possible to set only the first class. Valid values for relays switching are selected by the E/EC position.
- **SEt** (from 0 to max full scale; default: 0): Setpoint; relay switching occurs when the weight exceed the value set in this parameter. The type of switching is settable (see section **OUTPUTS AND INPUTS CONFIGURATION**).
- **HYSEt** (from 0 to max full scale; default: 0): Hysteresis, value to be subtracted from the setpoint to obtain contact switching for decreasing weight. For example with a setpoint at 100 and hysteresis at 10, the switching occurs at 90 for decreasing weight.



These values are set to zero if the calibration is changed significantly (see sections **THEORETICAL CALIBRATION** and **REAL CALIBRATION (WITH SAMPLE WEIGHTS)**).

ITEM DATABASE

The instrument has an available database with 99 items: for each item, it is possible to set a name, preset tare, three setpoints and two (HIGH and LOW) weight thresholds.

SETTING AND SELECTION OF ITEMS

 > ITEM

Set the following parameters for each item:

- > NAME item name/code
- > PTARE preset tare
- > HIGH weight value above which the display reads HIGH
- > LOW weight value below which the display reads LOW
- > SETP1 weight value above which output 1 is switched
- > SETP2 weight value above which output 2 is switched
- > SETP3 weight value above which output 3 is switched

Press  to activate the required item, press  to print out a summary of parameters.

TOTALIZER

The instrument includes a manual or automatic weighed value totalization function with database item association: for each item, the totalized weight value and number of totalizations performed since the latest deleting are stored.

TOTALIZER SETTING

 > MODE > TOTALIZER

Set the following parameters:

- > LOT lot name/code
- > ITEM select the required item and set the following parameters:
 - > NAME item name/code
 - > PTARE preset tare
 - > HIGH weight value above which the display reads HIGH
 - > LOW weight value below which the display reads LOW
 - > SETP1 value of the totalized weight above which output 1 is switched
 - > SETP2 weight value above which output 2 is switched

- > SETP3 weight value above which output 3 is switched
- > TOTALS it displays the totals for the selected item

Press  to activate the required item, press  to print out a summary of parameters.

- > TOTALIZER set the following parameters:
 - > TYPE manual/automatic
 - > MIN weight value below which the scale must come back between one weighing cycle and the next
 - > STABLE totalizing is only allowed with a stable weight
 - > CHANGE totalizing is only allowed if the weight has changed between two successive totalizations

- > PRINT select the data to print out during totalization:
 - > ALL for each totalization, the current weight, the totalized weight and the number of totalizations are printed out
 - > TOTALS upon each totalization, there is no printout

USING THE TOTALIZER

DISPLAY

WDESK-G, WINOX-G, WTAB-G





WINOX-2G, WTAB-2G



- 1) Net weight value
- 2) Latest deleting date
- 3) Number of weighed values since the latest deleting
- 4) Totalized weight value since the latest deleting

INCREASING MANUAL TYPE

Place the product on the scale:



- press  or close the input set as **LEGAL** to totalize the weight;
 - press  to delete the totalized value;
 - press  to display the gross weight on a maximized screen;
 - press **PRINT** to print out the totalized value;
- remove the product and repeat for the next product.

DECREASING MANUAL TYPE





To use this mode, it is mandatory to set the minimum weight to 0.

Place the product on the scale, press **TARE** and remove the required amount:

- press  or close the input set as **LEGAL** to totalize the weight, the instrument will calculate a semi-automatic tare;
 - press  to delete the totalized value;
 - press  to display the gross weight on a maximized screen;
 - press **PRINT** to print out the totalized value;
- proceed by removing the next amount of product.

AUTOMATIC TYPE

Place the product on the scale:

- weight is automatically totalized when the following conditions are met:
 - the weight is stable;
 - the weight has gone back to below the minimum weight value since the latest totalization;
 - the weight is higher than the minimum weight;
 - press  to delete the totalized value;
 - press  to display the gross weight on a maximized screen;
 - press **PRINT** to print out the totalized value;
- remove the product and repeat for the next product.

AUTOMATIC DELETING



> TOTALIZER > NUMBER

It sets the number of totalizations after which the automatic total deleting and printout is performed. By setting 0, the function is disabled.

TOTALIZER DEACTIVATION

To exit totalizer mode and return to standard operation:



> MODE > STANDARD

PIECE COUNTER

The instrument includes a piece counter function with database item association: for each item, the weight values, the number of totalized pieces and the number of totalizations performed since the latest deleting are stored.

PIECE COUNTER SETTING



> MODE > PCS COUNTER

Set the following parameters:

- > LOT lot name/code
- > ITEM select the required item and set the following parameters:
 - > NAME item name/code
 - > PTARE preset tare
 - > PMU Average Unit Weight (in thousandths of the unit of measure)
 - > HIGH weight value above which the display reads HIGH
 - > LOW weight value below which the display reads LOW
 - > SETP1 number of totalized pieces above which output 1 is switched
 - > SETP2 number of pieces above which output 2 is switched
 - > SETP3 number of pieces above which output 3 is switched
 - > TOTALS it displays the totals for the selected item

Press  to activate the required item, press  to print out a summary of parameters.

- > PRINT select the data to print out during totalization:
 - > ALL for each totalization, the current weight, the totalized weight the and number of totalizations are printed out
 - > TOTALS upon each totalization, there is no printout

USING THE PIECE COUNTER

DISPLAY

WDESK-G, WINOX-G, WTAB-G

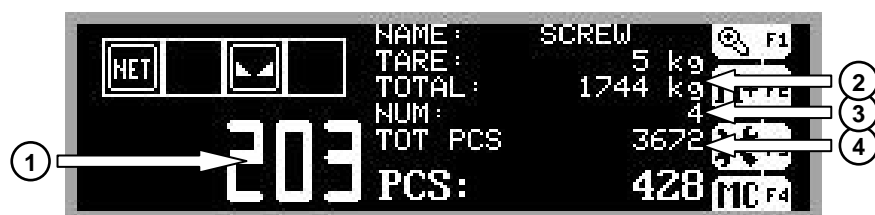

WINOX-2G, WTAB-2G



INCREASING OPERATION

Before using the piece counter function, the Average Unit Weight (PMU) of the required item must be calculated.

 > ITEM > PMU

The instrument displays the current PMU value; to carry out a new sampling:

- place an empty container on the scale and press **TARE**
- insert sample pieces in the container and press **ENTER**;
- set the number of sample pieces just loaded and confirm with **ENTER**;

The instrument will show the newly calculated PMU value.

Exit the menu and return to the main screen to use the piece counter.

Place the product on the scale:

- press **M+** or close the input set as **LEGAL** to totalize the weight and number of pieces;
- press **MC** to delete the totalized value;
- press **F1** to display the number of pieces on a maximized screen;
- press **PRINT** to print out the number of pieces on the scale;

DECREASING OPERATION

Before using the piece counter function, the Average Unit Weight (PMU) of the required item must be calculated.

 > ITEM > PMU



The instrument displays the current PMU value; to carry out a new sampling:

- place the container containing items on the scale and press **TARE**
- remove the sample items from the container and press **ENTER**
- set the number of just removed sample pieces and confirm with **ENTER**

The instrument will show the newly calculated PMU value.

Exit the menu and return to the main screen to use the piece counter.

Place the product on the scale:

- press  or close the input set as **TOTAL** to totalize the weight and number of pieces;
- press  to delete the totalized value;
- press  to display the number of pieces on a maximized screen;
- press **PRINT** to print out the number of pieces on the scale;

PIECE COUNTER DEACTIVATION

To exit piece counter mode and return to standard operation:

 > MODE > STANDARD

STATISTICAL CHECKING OF PREPACKAGES

The instrument has a statistical control function for “EEC pre-packaged goods” (referred to as “prepackages” here below), in accordance with Act no.690 dated 25/10/78 and DPR (Italian Presidential Decree) no.391 dated 26/05/80. Prepackage refers to a unit including the product and its packaging, sealed in the absence of its buyer, in which the amount of product is in accordance with a preset value not modifiable without obviously altering the package.

With this function, it is possible to carry out a sample check on the weight of large-sized lot prepackages, without having to perform a total lot check. The regulation defines the number of samples to be checked according to lot size and acceptability or rejectability terms applicable to the lot as a whole. During the control procedure, the instrument will check both the actual weight of individual samples, and the lot statistics according to the calculated average value.

CHOOSING A SCALE

In order to submit prepackages to adequate statistical checking, a scale should be used with divisions in accordance with the table here below, in relation to the nominal amount of product in the prepackage (named TARGET) to check.

TARGET starting from	Scale division
< 10 g	0.1 g
10 g	0.2 g
50 g	0.5 g
200 g	1.0 g
2 kg	2.0 g
5 kg	5.0 g
10 kg	10 g
20 kg	20 g
50 kg	50 g

TOLERANCE ZONES AND ACCEPTABILITY CRITERIA

Given the prepackage TARGET weight (T_0), enter the tolerance values T_{OLL1} according to the table here below, and $T_{OLL2} = 2 \times T_{OLL1}$.

TARGET WEIGHT (T_0)	T_{OLL1}
$5 \div 49$ g	9.0%
$50 \div 99$ g	4.5 g
$100 \div 199$ g	4.5%
$200 \div 299$ g	9.0 g
$300 \div 499$ g	3.0%
$500 \div 999$ g	15 g
$1000 \div 9999$ g	1.5%
$10000 \div 14999$ g	150 g
$15000 \div$ oltre 15000 g	1.0%

Five tolerance zones are identified: according to the zone each sample falls into, the corresponding lot acceptability is determined.

0	$T_0 - T_2$	$T_0 - T_1$	T_0	$T_0 + T_1$	$T_0 + T_2$	F.S.
ZONA1	ZONA2	ZONA3		ZONA4	ZONA5	

Example:

Prepackage nominal quantity: $T_0 = 150$ g

The table shows that: $T_{OLL1} = 4.5\%$ of 150 g = 6.75 g
 $T_{OLL2} = 2 \times T_1 = 2 \times 6.75 = 13.5$ g

Tolerance zones:

ZONE 1: $0 < \text{weight} < T_0 - T_{OLL2} = 0 \div 136.5$ g
 ZONE 2: $T_0 - T_{OLL2} < \text{weight} < T_0 - T_{OLL1} = 136.5 \text{ g} \div 143.25$ g
 ZONE 3: $T_0 - T_{OLL1} < \text{weight} < T_0 + T_{OLL1} = 143.25 \text{ g} \div 156.75$ g
 ZONE 4: $T_0 + T_{OLL1} < \text{weight} < T_0 + T_{OLL2} = 156.75 \text{ g} \div 163.5$ g
 ZONE 5: $T_0 + T_{OLL2} < \text{weight} < \text{F.S.} = 163.5 \text{ g} \div \text{F.S.}$

The zones 3, 4 and 5 are considered acceptable: all the samples falling within these zones are accepted.

Zone 2 is considered faulty: according to how many samples fall within this zone, a lot may be either accepted or rejected (see table here below).

Zone 1 is considered not acceptable: if even just one sample falls within this zone, the lot must be rejected.

There are three possible types of statistical check:

- STANDARD: it does not imply package opening and the number of samples to test depends on the size of the lot.
- DESTRUCTIVE: it implies the opening or destruction of the package and may only be used for lots including more than 100 units; being less effective than standard checking, it should only be used when no other solution is viable.
- INTEGRAL: complete lot check.

The number of samples to inspect depends on lot size and is determined by law. If the first inspection (SESSION 1) is inconclusive, it will be necessary to continue the inspection by acquiring more samples (SESSION 2).

The table shows the number of faulty samples (zone 2) that determine the acceptability or rejectability of a lot.

STANDARD				
Size	Session	Samples	Acceptability	Rejectability
< 100	1	ALL	-	1
100 ÷ 500	1	30	1	3
100 ÷ 500	2	30+30	4	5
501 ÷ 3200	1	50	2	5
501 ÷ 3200	2	50+50	6	7
oltre 3200	1	80	3	7
oltre 3200	2	80+80	8	9
DESTRUCTIVE				
> 100	1	20	1	2

Example:

150 units lot, in the first sampling session, 30 pieces are inspected, none is in ZONE 1:

- If the number of samples in ZONE 2 = 1, the lot is accepted.
- If the number of samples in ZONE 2 ≥ 3, the lot is rejected.
- If the number of samples in ZONE 2 = 2, another sampling session is started (30 more pieces) and the results of both sessions are added:
 - If the number of samples in ZONE 2 ≤ 4, the lot is accepted.
 - If the number of samples in ZONE 2 ≥ 5, the lot is rejected.

After the application of the first acceptability criterion to the lot (actual check), the regulation also prescribes a statistical check based on the average prepackage weight according to lot size.

STANDARD			
Size	Samples	Acceptability	Rejectability
100 ÷ 500	30	$\bar{X} \geq T_0 - 0,503\sigma$	$\bar{X} < T_0 - 0,503\sigma$
501 ÷ 3200	50	$\bar{X} \geq T_0 - 0,379\sigma$	$\bar{X} < T_0 - 0,379\sigma$
DESTRUCTIVE			
> 100	20	$\bar{X} \geq T_0 - 0,640\sigma$	$\bar{X} < T_0 - 0,640\sigma$

Where:

- \bar{X} is the average sample weight;
- T_0 is the nominal weight (or TARGET) of the sample;
- σ is the standard deviation.

If this second criterion is also successfully applied, the lot will be accepted.

STATISTICAL CHECK ACTIVATION

To access the statistical check function:

 > MODE > LOT CHECK

Set the following parameters:

- > LOT lot name/code

- > ITEM select the required item and set the following parameters:
 - > NAME item name/code
 - > PTARE preset tare
 - > TARGET prepackage nominal weight (T_0)
 - > TOL1 first tolerance threshold (T_{OLL1})
 - > TOL2 second tolerance threshold (T_{OLL2})

Press  to activate the required item, press  to print out a summary of parameters.

- > TYPE type of check to carry out
(STANDARD/DESTRUCTIVE/INTEGRAL)

- > QUANTITY number of items the lot consists of; the instrument automatically
calculates the number of samples to check

To start a statistical check, select START, the instrument will show the following screen display:

WDESK-G, WINOX-G, WTAB-G



- 1) Net weight value
- 2) Net weight displayed on a maximized screen
- 3) Nominal weight value
- 4) Samples acquired / to be acquired
- 5) Sample tolerance zone

WINOX-2G, WTAB-2G



- 1) Net weight value
- 2) Net weight displayed on a maximized screen
- 3) Nominal weight value
- 4) Samples acquired / to be acquired
- 5) Sample tolerance zone

The check automatically ends when the preset number of samples is reached.

To manually stop the check and declare the lot rejected:

 > STOP

SAMPLE CHECKING PROCEDURE

Place the first sample on the scale, the instrument will show the corresponding weight and tolerance zone.

Press **M+** or close the input set as **LOL** to acquire the sample and print out its details; the number of checked samples is increased.

Remove the sample from the scale and repeat for the next one.

When the preset number of samples is reached, the display will show:

- SUCCESS: if the lot is accepted;
- FAILURE: if the lot is rejected;

If the check is inconclusive, the instrument will automatically prepare for a second checking session.

STATISTICAL CHECK DEACTIVATION

To exit the statistical check mode and return to standard operation:

X > MODE > STANDARD

ALARMS

ErCEL: the load cell is not connected or is incorrectly connected; the load cell signal exceeds 39 mV; the conversion electronics (AD converter) is malfunctioning; the load cell is a 4-wire and there are no jumpers between EX- and REF- and between EX+ and REF+.

Er DL: the weight display exceeds 110% of the full scale.

Er Ad: internal instrument converter failure; check load cell connections, if necessary contact technical assistance.

-----: the weight exceeds the maximum capacity by 9 divisions.

Er DF: maximum displayable value exceeded (value higher than 999999 or lower than -999999).

E-----: weight too high: zero setting not possible.

PAH-PU: this message appears in the sample weight setting, in real calibration, after the fifth sample weight value has been entered.

Error: the value set for the parameter is beyond the permitted values; press **ESC** to quit the setting mode leaving the previous value unchanged. Examples: a number of decimals is selected for full scale which exceeds the instrument's display potential; value above the maximum setting value; the weight value set in sample weight verification does not match the detected mV increase; the analog output correction goes beyond the permitted limits.

hLDC: lock active on menu item, keypad or display.

n0d SP: It's not possible to display properly the number because is greater than 999999 or less than -999999.

bAŁŁŁ: buffer battery low, loss of date and time of Real-Time Clock. Confirm with **ENTER** to continue; leave the instrument on for at least 12 hours to charge the battery, if the alarm persists contact technical assistance.

dAŁŁP: an incorrect date has been detected: go into the related menu to check and correct it.

uŁŁŁL: unstable weight: zero-setting or net weight not possible.

Ł Ł Ł: the weight did not go below the minimum weight: it is not possible to print it out or save it.

Ł Ł: weight below minimum preset weight: cannot be printed out or saved.

ŁĤAŁŁ: weight has not changed: not possible to print or save.

Serial protocol alarms:

	<i>Er CEL</i>	<i>Er OL</i>	<i>Er Ad</i>	-----	<i>Er OF</i>	t-----
MODE						
Bit LSB	76543210	76543210	76543210	76543210	76543210	The response to the zero command is a 'value not valid' error (error code 3)
Status Register MODBUS RTU	xxxxxxxx1	xxxx1xxx	xxxxxxxx1x	xxxxx1xx	On gross: xxx1xxxx On net: xx1xxxxx	
ASCII	__O-F__	__O-L__	__O-F__	__O-L__	__O-F__	&aa#CR
RIP *	__O-F__	__O-L__	__O-F__	__O-L__	__O-F__	__O-F__
HDRIP-N	<u>ERCEL</u>	<u>ER_OL</u>	<u>ER_AD</u>	#####	<u>ER_OF</u>	O__SET
CONTIN	<u>ERCEL</u>	<u>ER_OL</u>	<u>ER_AD</u>	^^^^^^	<u>ER_OF</u>	O__SET

* For RIP remote displays, if the message exceeds 5 digits the display reads -----.

With an alarm the relays open and the analog outputs go to the lowest possible value according to the following table:

RANGE	0÷20 mA	4÷20 mA	0÷5 V	0÷10 V	±10 V	±5 V
Output value	-0.2 mA	3.5 mA	-0.5 V	-0.5 V	0 V	0 V

PRINTING EXAMPLES

If the printer has been set (see section **SERIAL COMMUNICATION SETTINGS**), from the weight display press the **PRINT** key for less than 3 seconds:

BASIC PRINTOUT:

W--- BASE Addr:01
DATE: 12/09/11 14:48:12

GROSS 878 kg
NET 589 kg
TARE 289 kg

BASIC PRINTOUT (PEAK ENABLED):

W--- BASE Addr:01
DATE: 12/09/11 14:48:12

GROSS 1204 kg
NET 831 kg
TARE 373 kg
PEAK 2103 kg

PRINTOUT WITH **COEFF** ENABLED:

W--- BASE Addr:01
DATE: 12/09/11 15:07:41

UNIT	kg	bar
G	1195	1792
N	1195	1792
T	0	0

PIECE COUNTER:

press 

W--- BASE Addr:01
DATE: 18/04/12 15:27:10

GROSS 462 kg
NET 452 kg
PTARE 10 kg
ITEM: BULLONI
LOT: LOT-00015
NUM 2
TOTAL 724 kg
TOTAL PCS 94
PCS 59
PMU 759000

press 

W--- BASE Addr:01
DATE: 18/04/12 15:27:10

ITEM: BULLONI
LOT: LOT-00015
PCS 59
PMU 759000

TOTALIZER:

press 

W--- BASE Addr:01
DATE: 18/04/12 15:26:06

GROSS 282 kg
NET 272 kg
PTARE 10 kg
ITEM: BULLONI
LOT: LOT-00015
NUM 2
TOTAL 375 kg

press 

W--- BASE Addr:01
DATE: 18/04/12 15:25:56

ITEM: BULLONI
LOT: LOT-00015
NUM 1
TOTAL 103 kg

STATISTICAL CHECKING:

W--- BASE Addr:01
DATE: 18/04/12 15:20:32

LOT CHECK: STOP Lot check status
LOT: LOT-00015 Name of checked lot
ITEM: BULLONI Name of checked item

TARGET: 100 kg Product nominal net weight
Dev.Std: 2.257 kg Standard deviation
M.WEIGHT: 102.20 kg Average weight of checked samples
L.WEIGHT: 98.86 kg Minimum acceptable average weight

Z (%) NUM NET(kg) Summary of samples in tolerance zones
1: 000.0 000 0 ZONE 1
2: 000.0 000 0 ZONE 2
3: 096.6 029 2959 ZONE 3
4: 003.3 001 107 ZONE 4
5: 000.0 000 0 ZONE 5
T: 030 3066 Total checked samples

LOT CHECK: SUCCESS Statistical check outcome

Z3 SAMPLE 030/030 Tolerance zone and sample number
NET 103 kg Sample net weight
PTARE 10 kg Preset tare associated with item
Z3 SAMPLE 029/030
NET 103 kg
PTARE 10 kg
.
Z3 SAMPLE 002/030
NET 102 kg
PTARE 10 kg
Z3 SAMPLE 001/030
NET 102 kg
PTARE 10 kg

LOT CHECK: START Lot check status
DATE: 18/04/12 15:17:51 Lot check start date
LOT: LOT-00015 Name of checked lot
ITEM: BULLONI Name of checked item
TYPE: STANDARD Type of check performed
QUANTITY: 150 Quantity of elements in the lot

Z1: NET<90] Definition of tolerance zones with respect to sample net weight
Z2: 90<NET<95	
Z3: 95<NET<105	
Z4: 105<NET<110	
Z5: NET>110	



RESERVED FOR THE INSTALLER

MENU LOCKING

Through this procedure, it's possible to block the access to any menu on the instrument. Select the menu that you wish to lock:

press and simultaneously for 3 seconds, the display shows (the left point on the text indicates that this menu item is now locked). If the operator tries to enter this menu, the access is denied and the display shows .

MENU UNLOCKING

press and simultaneously for 3 seconds, the display shows (the left point on the text is off to indicate that this menu item is unlocked).

TEMPORARY MENU UNLOCKING

press and simultaneously for 3 seconds: it is now possible to enter and modify all menus including those which are locked. By returning to weight display, the menu lock is restored.

DATA DELETION AND PROGRAM SELECTION



WARNING: operations must only be performed after contacting technical assistance. After each operation the display shows *dOnE*, press to continue. By pressing the procedure is cancelled and no changes are made.

Upon instrument power-on hold down the key until the display shows *PrOG*, then proceed as follows:

CONSTANTS RESTORE (does not erase the calibration): confirm *PrOG*, use arrow keys to select *PA55U*, set code 6935 and confirm.

PROGRAM SELECTION: confirm *P-00* and use the arrow keys to select the desired program:

bPSE: basic program, setpoint management only.

rEUEr: to be used when the loaded weighing system correspond to not loaded cells and vice versa (product increases while weight on load cells actually decreases).

r rP: weight remote display program with setpoint.

After confirming the choice of the program (except *rEUEr* and *r rP*), the user must choose its approval state among the following possible choices:



r0tLEG: not approved program;

LEGAL: approved program, single division (Dir. 2014/31/EU, art. 1)*;

LEGNi: approved program, multi-interval (Dir. 2014/31/EU, art. 1)*;

LEGNr: approved program, multiple range (Dir. 2014/31/EU, art. 1)*;

- *) Contact technical assistance to request the proper manual and the correct procedures for approval, indicating mandatory hardware code and serial number (see section **INSTRUMENT COMMISSIONING**).

By confirming, the instrument is restored to default and data is erased.



If you do not have a specific manual for the newly set program, you can request it to technical assistance.

KEYPAD OR DISPLAY LOCKING

Press **ESC** immediately followed by **▲** hold them down for about 5 seconds (this operation is also possible via the MODBUS and ASCII protocols):

- *FrEE*: no lock.
- *HEy*: keypad lock: if active, when a key is pressed the message *bLOC* is displayed for 3 seconds.
- *dI SP*: keypad and display lock: if active, the keypad is locked and the display shows the instrument model (weight is not displayed); by pressing a key the display shows *bLOC* for 3 seconds.